

➤ Instructions

Thule Epos 3
9791, 9792





**EN**

TOW BAR-MOUNTED BIKE CARRIER

FAILURE TO COMPLY WITH THE MANUFACTURER'S INSTRUCTIONS CAN LEAD TO SERIOUS INJURY OR DEATH.

IMPORTANT - READ CAREFULLY AND KEEP FOR FUTURE REFERENCE.

 **WARNING** INDICATES A HAZARDOUS SITUATION WHICH, IF NOT AVOIDED, COULD RESULT IN DEATH OR SERIOUS INJURY.

 **NOTE** INDICATES ADDITIONAL INFORMATION THAT IS USEFUL FOR TROUBLE-FREE AND OPTIMAL USE OF THE PRODUCT.

FR

PORTE-VÉLOS SUR BOULE D'ATTELAGE

LE NON-RESPECT DES INSTRUCTIONS DU FABRICANT PEUT ENTRAÎNER DES BLESSURES GRAVES OU LA MORT.

IMPORTANT - LISEZ ATTENTIVEMENT CES INSTRUCTIONS ET CONSERVEZ-LES POUR RÉFÉRENCE FUTURE..

 **AVERTISSEMENT** INDIQUE UNE SITUATION POTENTIELLEMENT DANGEREUSE QUI, SI ELLE N'EST PAS ÉVITÉE, POURRAIT PROVOQUER DES BLESSURES GRAVES, VOIR MORTELLES.

 **REMARQUE** INDIQUE COMMENT RÉPONDRE À UNE SITUATION DONNÉE U VOUS DONNENT DES CONSEILS SUR LE FONCTIONNEMENT DES OPTIONS DISPONIBLES.

ES

PORTABICICLETAS DE BOLA DE REMOLQUE

EL INCUMPLIMIENTO DE LAS INSTRUCCIONES DEL FABRICANTE PUEDE PROVOCAR LESIONES GRAVES O LA MUERTE.

IMPORTANTE - LEA ATENTAMENTE Y CONSERVELO PARA FUTURAS CONSULTAS.

 **ADVERTENCIA** INDICA UNA SITUACIÓN DE PELIGRO QUE, SI NO SE EVITA, PODRÍA PROVOCAR LESIONES GRAVES O INCLUSO LA MUERTE.

 **NOTA** INDICA INFORMACIÓN ADICIONAL QUE ES ÚTIL PARA UN USO ÓPTIMO Y SIN PROBLEMAS DEL PRODUCTO.

DE

FAHRRADTRÄGER FÜR DIE ANHÄNGERKUPPLUNG

DIE NICHTEINHALTUNG DER ANWEISUNGEN DES HERSTELLERS KANN ZU SCHWEREN VERLETZUNGEN ODER ZUM TOD FÜHREN.

WICHTIG - LESEN SIE DIESE ANLEITUNG SORGFÄLTIG DURCH UND BEWAHREN SIE ZUM NACHSCHLAGEN AUF.

 **WARNUNG** WEIST AUF EINE GEFÄHRLICHE SITUATION HIN, DIE ZU SCHWERWIEGENDEN VERLETZUNGEN ODER ZUM TODE FÜHREN KANN, WENN SIE NICHT VERMIEDEN WIRD.

 **HINWEIS** KENNZEICHNET ZUSÄTZLICHE INFORMATIONEN, DIE FÜR EINE STÖRUNGSFREIE UND OPTIMALE NUTZUNG DES PRODUKTS HILFREICH SIND

FIETSDRAGER VOOR OP DE TREKHAAK

HET NIET OPVOLGEN VAN DE INSTRUCTIES VAN DE FABRIKANT KAN LEIDEN TOT ERNSTIG LETSEL OF DE DOOD.

IBELANGRIJK - ZORGVULDIG LEZEN EN BEWAREN VOOR TOEKOMSTIG GEBRUIK.

 **WAARSCHUWING** DUIDT OP EEN GEVAARLIJKE SITUATIE DIE, INDIEN DEZE NIET WORDT VERMEDEEN, DE DOOD OF ERNSTIG LETSEL TOT GEVOLG KAN HEBBEN.

 **OPMERKING** GEEFT AANVULLENDE INFORMATIE AAN DIE NUTTIG IS VOOR EEN PROBLEEMLOOS EN OPTIMAAL GEBRUIK VAN HET PRODUCT.

SUPORTE PARA BICICLETA PARA ENGATE

O NÃO CUMPRIMENTO DAS INSTRUÇÕES DO FABRICANTE PODE LEVAR A FERIMENTOS GRAVES OU À MORTE.

IMPORTANTE - LEIA COM ATENÇÃO E GUARDE PARA REFERÊNCIA FUTURA

 **ATENÇÃO** INDICA UMA SITUAÇÃO PERIGOSA QUE, SE NÃO FOR EVITADA, PODE RESULTAR EM MORTE OU FERIMENTOS GRAVES.

 **NOTA** INDICA INFORMAÇÕES ADICIONAIS QUE SÃO ÚTEIS PARA O USO IDEAL E SEM PROBLEMAS DO PRODUTO.

PORTABICI DA INSTALLARE SUL GANCIO DA TRAINO

LA MANCATA OSSERVANZA DELLE ISTRUZIONI DEL PRODUTTORE PUÒ CAUSARE GRAVI LESIONI O MORTE.

IMPORTANTE - LEGGERE ATTENTAMENTE E CONSERVARE PER RIFERIMENTO FUTURO.

 **AVVERTENZA** INDICA UNA SITUAZIONE DI PERICOLO CHE, SE NON EVITATA, PUÒ CAUSARE MORTE O GRAVI LESIONI.

 **NOTA** INDICA INFORMAZIONI AGGIUNTIVE UTILI PER UN USO OTTIMALE E SENZA PROBLEMI DEL PRODOTTO.

DRAGKROKSMONTERAD
CYKELHÅLLARE

OM TILLVERKARENS ANVISNINGAR INTE FÖLJS KAN DET LEDA TILL ALLVARLIG SKADA ELLER DÖDSFALL.

VIKTIGT - LÄS INSTRUKTIONERNA NOGA OCH SPARA DEM FÖR FRAMTIDA BRUK.

 **VARNING** INDIKERAR EN FARLIG SITUATION SOM, OM DEN INTE UNDVIKS, KAN RESULTERA I DÖDSFALL ELLER ALLVARLIGA SKADOR.

 **OBS!** INNEHÅLLER YTTERLIGARE INFORMATION SOM ÄR ANVÄNDBAR FÖR PROBLEMFRI OCH OPTIMAL ANVÄNDNING AV PRODUKTEN.

CYKELHOLDER, DER ER MONTERET PÅ ANHÆNGERTRÆK

MANGLENDE OVERHOLDELSE AF PRO-
DUCENTENS ANVISNINGER KAN FØRE
TIL ALVORLIG PERSONSKADE ELLER
DØD.

VIKTIGT - LÆS OMHYGGELIGT OG OP-
BEVAR DEN TIL SENERE BRUG.

 **ADVARSEL** ANGIVER EN FARLIG
SITUATION, SOM, HVIS DEN IKKE UND-
GÅS, KAN FØRE TIL DØD ELLER ALVOR-
LIG PERSONSKADE.

 **BEMÆRK** ANGIVER YDERLIGERE
OPLYSNINGER, DER ER NYTTIGE FOR
PROBLEMFRI OG OPTIMAL BRUG AF
PRODUKTET.

HENGERFESTEMONTERTE LASTEHOLD- ERE

UNNLATELSE AV Å FØLGE PRODUSEN-
TENS INSTRUKSJONER KAN FØRE TIL
ALVORLIG PERSONSKADE ELLER DØD.

VIKTIG - LES NØYE OG OPPBEVAR FOR
FREMtidig REFERANSE.

 **ADVARSEL** INDIKERER EN FAR-
LIG SITUASJON SOM, HVIS DEN IKKE
UNNGÅS, KAN FØRE TIL DØD ELLER
ALVORLIG SKADE.

 **MERK** INDIKERER TILLEGGSINFOR-
MASJON SOM ER NYTTIG FOR PROBLEM-
FRI OG OPTIMAL BRUK AV PRODUKTET.

VETOKOUKKUUN KIINNITETTÄVÄ POLKUPYÖRÄTELINE

VALMISTAJAN OHJEIDEN NOUDAT-
TAMATTA JÄTTÄMINEN VOI JOHTAA
VAKAVAAN LOUKKAANTUMISEEN TAI
KUOLEMAAN.

TÄRKEÄ - LUE HUOLELLISESTI JA SÄI-
LYTÄ MYÖHEMPÄÄ KÄYTTÖÄ VARTEN.

 **VAROITUS** ILMAISEE VAARATILAN-
TEEN, JOKA VOI JOHTAA KUOLEMAAN
TAI VAKAVAAN LOUKKAANTUMISEEN,
JOS SITÄ EI VÄLTETÄ.

 **HUOMAUTUS** ILMAISEE LISÄTIETOJA,
JOTKA OVAT HYÖDYLLISIÄ TUOTTEEN
HÄIRIÖTTÖMÄN JA OPTIMAALISEN
KÄYTÖN KANNALTA.

HJÓLAGRIND Á DRÁTTARKÚLU

EF EKKI ER FARIÐ AÐ LEIÐBEININGUM
FRAMLEIÐANDA GETUR ÞAÐ LEITT TIL
ALVARLEGRA MEIÐSLA EÐA DAUÐA.

MIKILVÆGT - LESIÐU VARLEGA OG
HAFIÐU TIL FRAMTÍÐAR VIÐSLUNAR.

 **VIÐVÖRUN** GEFUR TIL KYNNA HÆT-
TULEGAR AÐSTÆÐUR SEM GÆTU LEITT
TIL DAUÐA EÐA ALVARLEGRA MEIÐSLA
EF EKKI ER VARIST.

 **ATH** GEFUR TIL KYNNA VIÐBÓTARUP-
PLÝSINGAR SEM ERU GAGNLEGAR FYRIR
VANDRÆÐALAUSA OG BESTU NOTKUN
VÖRUNNAR.

HAAKEKONKSULE PAIGALDATAV JAL-GRATTAHOIDIK

TOOTJA JUHISTE EIRAMINE VÕIB PÕHJUSTADA TÕSISEID VIGASTUSI VÕI SURMA.

OLULINE - LUGEGE HOOLIKALT LÄBI JA HOIDKE ALLES EDASPIDISEKS KASUTAMISEKS.

 **HOIATUS** TÄHISTAB OHTLIKKU OLUKORDA, MILLE VÄLTIMATA JÄTMINE VÕIB PÕHJUSTADA SURMA VÕI RASKEID VIGASTUSI.

 **MÄRKUS** TÄHISTAB LISATEAVET, MIS ON KASULIK TOOTE TÕRGETETA JA OPTIMAALSEKS KASUTAMISEKS.

UZ PIEKABES ĀĶA UZSTĀDĀMS VELOSIPĒDU TURĒTĀJS

RAŽOTĀJA NORĀDĪJUMU NEIEVĒROŠANA VAR IZRAISĪT NOPIETNAS TRAUMAS VAI NĀVI.

SVARĪGI - UZMANĪGI IZLASIET UN SAGLABĀJIET TURPMĀKAI LIETOŠANAI.

 **BRĪDINĀJUMS** NORĀDA BĪSTAMU SITUĀCIJU, KAS, JA NO TĀS NETIEK NOVĒRSTA, VAR IZRAISĪT NĀVI VAI NOPIETNUS IEVAINOJUMUS.

 **PIEZĪME** NORĀDA PAPILDU INFORMĀCIJU, KAS IR NODERĪGA, LAI BEZ PROBLĒMĀM UN OPTIMĀLI IZMANTOTU IZSTRĀDĀJUMU.

PRIE GRĄŽULO TVIRTINAMI DVIRAČIŲ LAIKIKLIAI

JEI NESILAIKYSITE GAMINTOJO NURODYMŲ, GALITE SUNKIAI SUSIŽEISTI ARBA ŽŪTI.

SVARBU - ATIDŽIAI PERSKAITYKITE IR IŠSAUGOKITE ATEITYJE.

 **ISPĖJIMAS** NURODO PAVOJINGĄ SITUACIJĄ, KURIOS NEIŠVENGUS GALI KILTI MIRTIS ARBA SUNKUS SUŽALOJIMAS.

 **PASTABA** NURODO PAPILDOMĄ INFORMACIJĄ, KURI YRA NAUDINGA NORINT BE SUTRIKIMŲ IR OPTIMALIAI NAUDOTI GAMINĮ.

УСТАНОВЛИВАЕМОЕ НА ФАРКОПЕ КРЕПЛЕНИЕ ДЛЯ ВЕЛОСИПЕДОВ

НЕСОБЛЮДЕНИЕ ИНСТРУКЦИЙ ПРОИЗВОДИТЕЛЯ МОЖЕТ ПРИВЕСТИ К СЕРЬЕЗНЫМ ТРАВМАМ ИЛИ СМЕРТИ.

ВАЖНО - ВНИМАТЕЛЬНО ПРОЧИТАЙТЕ И СОХРАНИТЕ ДЛЯ ДАЛЬНЕЙШЕГО ИСПОЛЬЗОВАНИЯ.

 **ПРЕДУПРЕЖДЕНИЕ** УКАЗЫВАЕТ НА ОПАСНУЮ СИТУАЦИЮ, КОТОРАЯ, ЕСЛИ ЕЕ НЕ ПРЕДОТВРАТИТЬ, МОЖЕТ ПРИВЕСТИ К СМЕРТИ ИЛИ СЕРЬЕЗНЫМ ТРАВМАМ.

 **ПРИМЕЧАНИЕ** УКАЗЫВАЕТ НА ДОПОЛНИТЕЛЬНУЮ ИНФОРМАЦИЮ, ПОЛЕЗНУЮ ДЛЯ БЕСПЕРЕБОЙНОГО И ОПТИМАЛЬНОГО ИСПОЛЬЗОВАНИЯ ИЗДЕЛИЯ.

БАГАЖНИК ДЛЯ ВЕЛОСИПЕДІВ, ЩО
МОНТУЄТЬСЯ НА БУКСИРНИЙ ШТАНС

НЕДОТРИМАННЯ ІНСТРУКЦІЙ
ВИРОБНИКА МОЖЕ ПРИЗВЕСТИ ДО
СЕРЬОЗНИХ ТРАВМ АБО СМЕРТІ.

ВАЖЛИВО - УВАЖНО ПРОЧИТАЙТЕ
ТА ЗБЕРЕЖІТЬ ДЛЯ ПОДАЛЬШОГО
ВИКОРИСТАННЯ.

 **ПОПЕРЕДЖЕННЯ** ВКАЗУЄ НА
НЕБЕЗПЕЧНУ СИТУАЦІЮ, ЯКА, ЯКЩО ЇЇ
НЕ УНИКНУТИ, МОЖЕ ПРИЗВЕСТИ ДО
СМЕРТІ АБО СЕРЬОЗНИХ ТРАВМ.

 **ПРИМІТКА** ВКАЗУЄ НА ДОДАТКОВУ
ІНФОРМАЦІЮ, КОРИСНУ ДЛЯ
БЕЗПЕРЕБІЙНОГО ТА ОПТИМАЛЬНОГО
ВИКОРИСТАННЯ ВИРОБУ.

BAGAŻNIK ROWEROWY MONTOWANY
NA HAKU

NIEPRZESTRZEGANIE INSTRUKCJI
PRODUCENTA MOŻE PROWADZIĆ DO
POWAŻNYCH OBRAŻEŃ LUB ŚMIERCI.

WAŻNE - PRZECZYTAJ UWAGNIE I
ZACHOWAJ DO WYKORZYSTANIA W
PRZYSZŁOŚCI.

 **OSTRZEŻENIE** WSKAZUJE NA
NIEBEZPIECZNĄ SYTUACJĘ, KTÓRA,
JEŚLI NIE ZOSTANIE UNIKNIĘTA, MOŻE
SPOWODOWAĆ ŚMIERĆ LUB POWAŻNE
OBRAŻENIA.

 **UWAGA** WSKAZUJE DODATKOWE
INFORMACJE, KTÓRE SĄ PRZYDATNE DO
BEZPROBLEMOWEGO I OPTIMALNEGO
UŻYTKOWANIA PRODUKTU.

NOSIČ JÍZDNÍCH KOL S MONTÁŽÍ NA
TAŽNÉ ZAŘÍZENÍ

NEDODRŽENÍ POKYŇŮ VÝROBCE MŮŽE
VÉST K VÁŽNÉMU ZRANĚNÍ NEBO SMRTI.

DŮLEŽITÉ - PEČLIVĚ SI PŘEČTĚTE A
USCHOVEJTE PRO BUDOUCÍ POUŽITÍ.

 **VAROVÁNÍ** OZNAČUJE
NEBEZPEČNOU SITUACI, KTERÁ BY
MOHLA VÉST K USMRČENÍ NEBO
VÁŽNÉMU ZRANĚNÍ, POKUD SE JÍ
NEZABRÁNÍ.

 **POZNÁMKA** OZNAČUJE DOPLNŮJÍCÍ
INFORMACE, KTERÉ JSOU UŽITEČNÉ
PRO BEZPROBLÉMOVÉ A OPTIMÁLNÍ
POUŽÍVÁNÍ VÝROBKU.

VONÓHOROGRA SZERELHETŐ KERÉK-
PÁRTARTÓ

A GYÁRTÓ UTASÍTÁSAINAK BE NEM
TARTÁSA SÚLYOS SÉRÜLÉSHEZ VAGY
HALÁLHOZ VEZETHET.

FONTOS - OLVASSA EL FIGYELMESEN, ÉS
ŐRIZZE MEG A KÉSŐBBI HASZNÁLATRA.

 **FIGYELMEZTETÉS** OLYAN VESZÉ-
LYES HELYZETET JELEZ, AMELY, HA NEM
KERÜLJÜK EL, HALÁLHOZ VAGY SÚLYOS
SÉRÜLÉSHEZ VEZETHET.

 **MEGJEGYZÉS** A TERMÉK PROBLÉMA-
MENTES ÉS OPTIMÁLIS HASZNÁLATÁHOZ
HASZNOS KIEGÉSZÍTŐ INFORMÁCIÓKAT
JELÖL.

SUPORT PENTRU BICICLETĂ MONTAT PE BARA DE TRACȚIUNE

NERESPECTAREA INSTRUCȚIUNILOR PRODUCĂTORULUI POATE DUCE LA VĂTĂMĂRI GRAVE SAU LA DECES.

IMPORTANT - CITIȚI CU ATENȚIE ȘI PĂSTRAȚI PENTRU REFERINȚE VIITOARE.



AVERTISMENT INDICĂ O SITUAȚIE PERICULOASĂ CARE, DACĂ NU ESTE EVITATĂ, AR PUTEA DUCE LA DECES SAU VĂTĂMĂRI GRAVE.

i NOTĂ INDICĂ INFORMAȚII SUPLIMENTARE CARE SUNT UTILE PENTRU UTILIZAREA OPTIMĂ ȘI FĂRĂ PROBLEME A PRODUSULUI.

NOSIČ BICYKLOV S MONTÁŽOU NA ŤAŽNÉ ZARIADENIE

NEDODRŽANIE POKYNOV VÝROBCU MÔŽE VIESŤ K VÁŽNEMU ZRANENIU ALEBO SMRTI.

DÔLEŽITÉ - POZORNE SI PREČÍTAJTE A USCHOVAJTE PRE BUDÚCE POUŽITIE.



VAROVANIE OZNAČUJE NEBEZPEČNÚ SITUÁCIU, KTORÁ MÔŽE MAŤ ZA NÁSLEDOK SMŤ ALEBO VÁŽNE ZRANENIE, AK SA JEJ NEZABRÁNI.

i POZNÁMKA OZNAČUJE DODATOČNÉ INFORMÁCIE, KTORÉ SÚ UŽITOČNÉ PRE BEZPROBLÉMOVÉ A OPTIMÁLNE POUŽÍVANIE VÝROBKU.

PRTLJAŽNIK ZA KOLESA ZA NA VLEČNO KLJUKO

NEUPOŠTEVANJE NAVODIL PROIZVAJALCA LAHKO POVZROČI HUDE TELESNE POŠKODBE ALI SMRT.

POMEMBNO - POZORNO PREBERITE IN SHRANITE ZA PRIHODNJO UPORABO.



OPOZORILO OZNAČUJE NEVARNO SITUACIJO, KI LAHKO POVZROČI SMRT ALI HUDE TELESNE POŠKODBE, ČE SE JI NE IZOGNETE.

i OPOMBA OZNAČUJE DODATNE INFORMACIJE, KI SO KORISTNE ZA NEMOTENO IN OPTIMALNO UPORABO IZDELKA.

БАГАЖНИК ЗА ВЕЛОСИПЕДИ, МОНТИРАН НА ТЕГЛИЧА

НЕСПАЗВАНЕТО НА ИНСТРУКЦИИТЕ НА ПРОИЗВОДИТЕЛЯ МОЖЕ ДА ДОВЕДЕ ДО СЕРИОЗНО НАРАНЯВАНЕ ИЛИ СМЪРТ.

ВАЖНО - ПРОЧЕТЕТЕ ВНИМАТЕЛНО И ЗАПАЗЕТЕ ЗА БЪДЕЩИ СПРАВКИ.



ПРЕДУПРЕЖДЕНИЕ ПОКАЗВА ОПАСНА СИТУАЦИЯ, КОЯТО, АКО НЕ БЪДЕ ИЗБЕГНАТА, МОЖЕ ДА ДОВЕДЕ ДО СМЪРТ ИЛИ СЕРИОЗНО НАРАНЯВАНЕ.

i ЗАБЕЛЕЖКА ПОКАЗВА ДОПЪЛНИТЕЛНА ИНФОРМАЦИЯ, КОЯТО Е ПОЛЕЗНА ЗА БЕЗПРОБЛЕМНО И ОПТИМАЛНО ИЗПОЛЗВАНЕ НА ПРОДУКТА.

NOSAČ BICIKLA KOJI SE POSTAVLJA NA KUKU ZA VUČU

NEPOŠTIVANJE UPUTA PROIZVOĐAČA MOŽE DOVESTI DO OZBILJNIH OZLJEDA ILI SMRTI.

VAŽNO - PAŽLJIVO PROČITAJTE I SAČUVAJTE ZA BUDUĆU REFERENCU.

 **UPOZORENJE** OZNAČAVA OPASNU SITUACIJU KOJA, AKO SE NE IZBJEGNE, MOŽE DOVESTI DO SMRTI ILI OZBILJNE OZLJEDE.

 **NAPOMENA** OZNAČAVA DODATNE INFORMACIJE KOJE SU KORISNE ZA NEOMETANO I OPTIMALNO KORIŠTENJE PROIZVODA.

ΣΧΑΡΑ ΠΟΔΗΛΑΤΟΥ ΚΟΤΣΑΔΟΡΟΥ

Η ΜΗ ΣΥΜΜΟΡΦΩΣΗ ΜΕ ΤΙΣ ΟΔΗΓΙΕΣ ΤΟΥ ΚΑΤΑΣΚΕΥΑΣΤΗ ΜΠΟΡΕΙ ΝΑ ΟΔΗΓΗΣΕΙ ΣΕ ΣΟΒΑΡΟ ΤΡΑΥΜΑΤΙΣΜΟ Η ΘΑΝΑΤΟ.

ΣΗΜΑΝΤΙΚΟ - ΔΙΑΒΑΣΤΕ ΠΡΟΣΕΚΤΙΚΑ ΚΑΙ ΦΥΛΑΞΤΕ ΤΟ ΓΙΑ ΜΕΛΛΟΝΤΙΚΗ ΑΝΑΦΟΡΑ.

 **ΠΡΟΕΙΔΟΠΟΙΗΣΗ** ΥΠΟΔΕΙΚΝΥΕΙ ΜΙΑ ΕΠΙΚΙΝΔΥΝΗ ΚΑΤΑΣΤΑΣΗ Η ΟΠΟΙΑ, ΕΑΝ ΔΕΝ ΑΠΟΦΕΥΧΘΕΙ, ΜΠΟΡΕΙ ΝΑ ΟΔΗΓΗΣΕΙ ΣΕ ΘΑΝΑΤΟ Η ΣΟΒΑΡΟ ΤΡΑΥΜΑΤΙΣΜΟ.

 **ΣΗΜΕΙΩΣΗ** ΥΠΟΔΕΙΚΝΥΕΙ ΠΡΟΣΘΕΤΕΣ ΠΛΗΡΟΦΟΡΙΕΣ ΠΟΥ ΕΙΝΑΙ ΧΡΗΣΙΜΕΣ ΓΙΑ ΤΗΝ ΑΠΡΟΣΚΟΠΤΗ ΚΑΙ ΒΕΛΤΙΣΤΗ ΧΡΗΣΗ ΤΟΥ ΠΡΟΪΟΝΤΟΣ.

ÇEKİ DEMİRİNE BAĞLANAN BİSİKLET TAŞIYICI

ÜRETİCİNİN TALİMATLARINA UYULMAMASI CİDDİ YARALANMALARA VEYA ÖLÜME YOL AÇABİLİR.

ÖNEMLİ - DİKKATLİCE OKUYUN VE İLERİDE BAŞVURMAK ÜZERE SAKLAYIN.

 **UYARI** ÖNLENMEDİĞİ TAKDİRDE ÖLÜM VEYA CİDDİ YARALANMAYLA SONUÇLANABİLECEK TEHLİKELİ BİR DURUMU BELİRTİR.

 **NOT** ÜRÜNÜN SORUNSUZ VE OPTİMUM KULLANIMI İÇİN YARARLI OLAN EK BİLGİLERİ BELİRTİR.

PEMBAWA BASIKAL YANG DIPASANG PADA BAR TUNDA

IN-NUQQAS TA' KONFORMITÀ MAL-IS-TRUZZJONIJIET TAL-MANIFATTUR JISTA' JWASSAL GĦAL KORRIMENT SERJU JEW MEWT.

IMPORTANTI - AQRA B'ATTENZJONI U ŻOMM GĦAL REFERENZA FUTUR.

 **TWISSIJA** TINDIKA SITWAZZJONI PERIKOLUŻA LI, JEKK MA TIĠIX EVITATA, TISTA' TIRRIŻULTA F'MEWT JEW KORRIMENT SERJU.

 **NOTA** TINDIKA INFORMAZZJONI ADDIZZJONALI LI HIJA UTLI GĦALL-UŻU OTTIMALI U MINGĦAJR PROBLEMI TAL-PRODOTT.

מנשא אופניים המורכב על וו הגרירה
אי ציות להוראות היצרן עלול להוביל
לפציעה חמורה או למוות.
חשוב - קרא בעיון ושמור לעיון עתידי.

אזהרה 

אזהרה מציין מצב מסוכן שאם לא מנמך
עלול לגרום למוות או לפציעה חמורה.

הערה 

הערה מציין מידע נוסף שימושי לשימוש
אופטימלי ללא תקלות במוצר.

拖杆安装式托架

不遵守制造商的说明可能会导致严重伤害或死亡。

重要 - 请仔细阅读并保留以备将来参考。

警告  表示危险情况, 如果不避免, 可能会导致死亡或重伤。

注意  表示对产品的无故障和最佳使用有用附加信息。

حامل الدراجة للتركيب على قضيب القطر

قد يؤدي عدم الامتثال لتعليمات الشركة المصنعة
إلى إصابة خطيرة أو الوفاة.

هام - اقرأ بعناية واحتفظ به للرجوع إليه في
المستقبل.

تحذير  يشير إلى موقف خطير ، إذا لم يتم
تجنبه ، فقد يؤدي إلى الوفاة أو الإصابة الخطيرة.

ملاحظة  تشير إلى معلومات إضافية مفيدة
للاستخدام الخالي من المتاعب والأمثل للمنتج

拖桿式自行車架

不遵守製造商的說明可能會導致嚴重傷害或死亡。

重要 - 請仔細閱讀並保留以備將來參考。

警告  表示危險情況, 如果不避免, 可能會導致死亡或重傷。

注意  表示對產品的無故障和最佳使用有用的附加信息。

トウバーマウント型サイクルキャリア

製造元の指示に従わない場合、重傷または死亡に至る可能性があります。

重要-注意深く読み、将来の参考のために保管してください。

 **警告** 回避しないと、死亡または重傷を負う可能性がある危険な状況を示します。

 **注記** 製品を最適かつトラブルなく使用するために役立つ追加情報を示します。

토우바 장착 자전거 캐리어

제조업체의 지침을 따르지 않으면 심각한 부상이나 사망에 이를 수 있습니다.

중요 - 주의 깊게 읽고 나중에 참조할 수 있도록 보관하십시오.

 **경고** 피하지 않을 경우 사망이나 중상을 입을 수 있는 위험한 상황을 나타냅니다.

 **주의** 제품을 문제 없이 최적으로 사용하는 데 유용한 추가 정보를 나타냅니다.

ควรยึดจับจักรยานแบบติดตั้งกับอุปกรณ์ลากพ่วง
ที่ปลอดภัย

การไม่ปฏิบัติตามคำแนะนำของผู้ผลิตอาจนำไปสู่
การบาดเจ็บสาหัสหรือเสียชีวิตได้

สำคัญ - อ่านอย่างระมัดระวังและเก็บไว้สำหรับ
การอ้างอิงในอนาคต.

 **คำเตือน** ระบุสถานการณ์อันตรายซึ่งหาก
ไม่หลีกเลี่ยง อาจส่งผลให้เสียชีวิตหรือบาดเจ็บ
สาหัสได้

 **หมายเหตุ** ระบุข้อมูลเพิ่มเติมที่เป็นประโยชน์
สำหรับการใช้ผลิตภัณฑ์โดยปราศจากปัญหาและ
เหมาะสมที่สุด.

GARRIER TAR-ROTI IMMUNTAT
B'VIRGA GHALL-IRMONKAR

KEGAGALAN MEMATUHI ARAHAN
PENGILANG BOLEH MENGAKIBAT-
KAN KECEDEeraan SERIUS ATAU
KEMATIAN.

PENTING - BACA DENGAN TELITI
DAN SIMPAN UNTUK RUJUKAN MASA
HADAPAN.

 **AMARAN** MENUNJUKKAN SITU-
ASI BERBAHAYA YANG, JIKA TIDAK
DIELAKKAN, BOLEH MENGAKIBAT-
KAN KEMATIAN ATAU KECEDEeraan
SERIUS.

 **NOTA** MENUNJUKKAN MAKLUMAT
TAMBAHAN YANG BERGUNA UNTUK
PENGUNAAN PRODUK YANG OPTI-
MUM DAN BEBAS MASALAH.

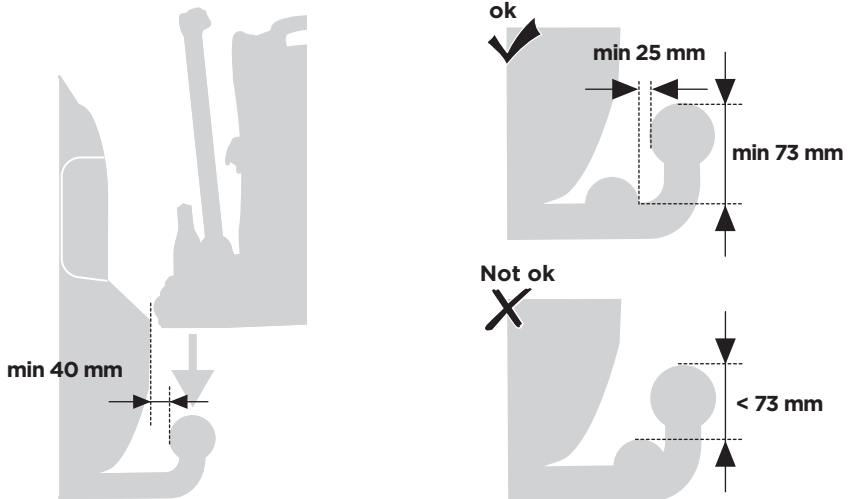
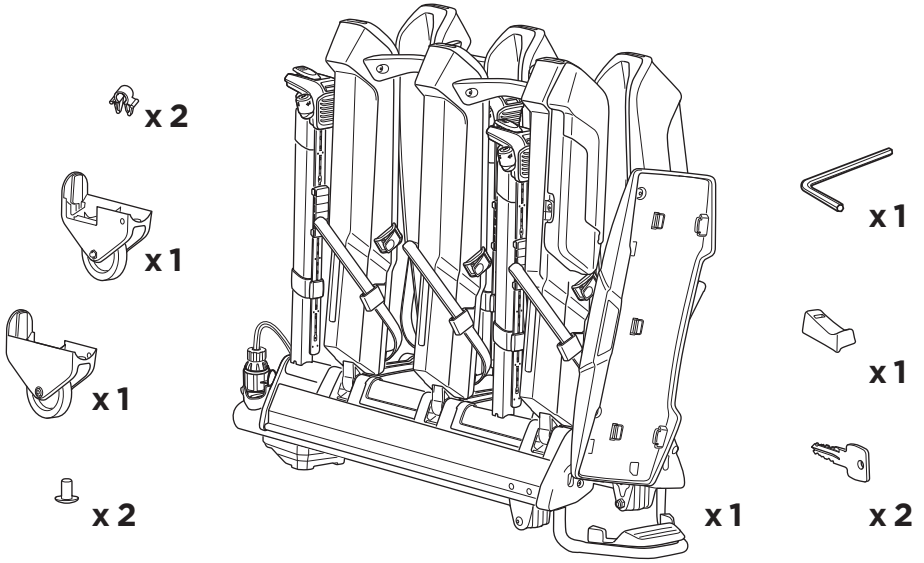

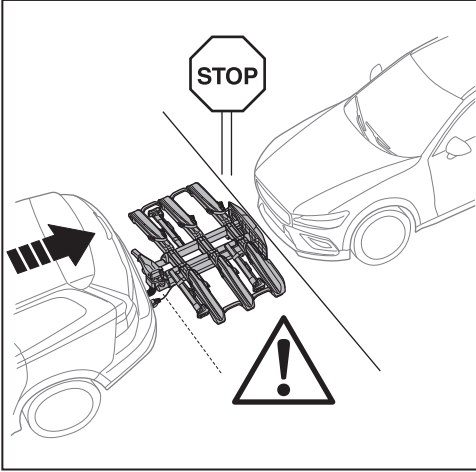

Your Key-Number

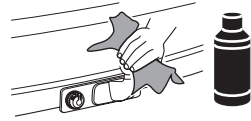

D.1

Aluminium
or GGG40

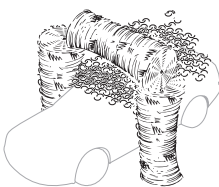
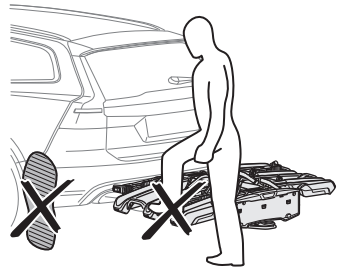
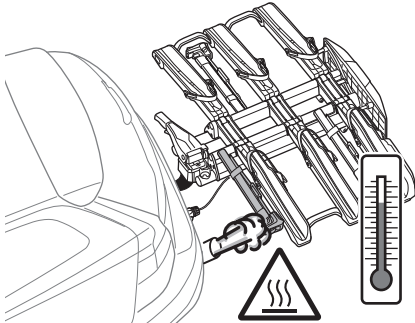
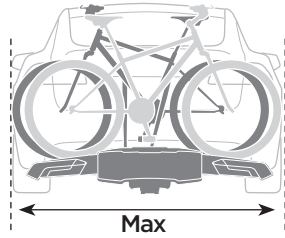
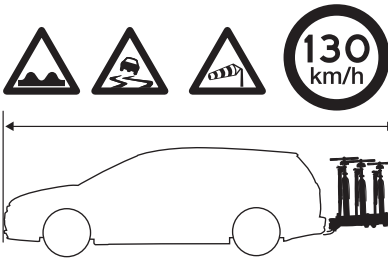

Safety

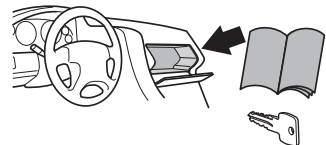

Not ok

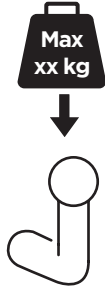



40 kg	 22.5 kg	Max 17.5 kg
50 kg		Max 27.5 kg
60 kg		Max 37.5 kg
70 kg		Max 47.5 kg
80 kg		Max 57.5 kg
90 kg		Max 60 kg 

1

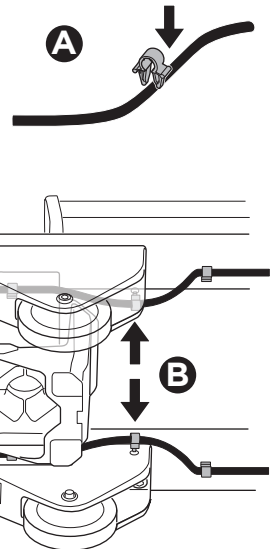
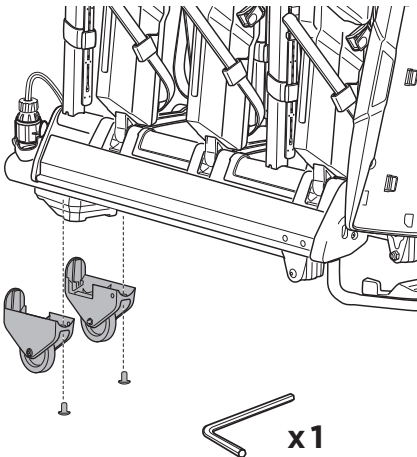

2

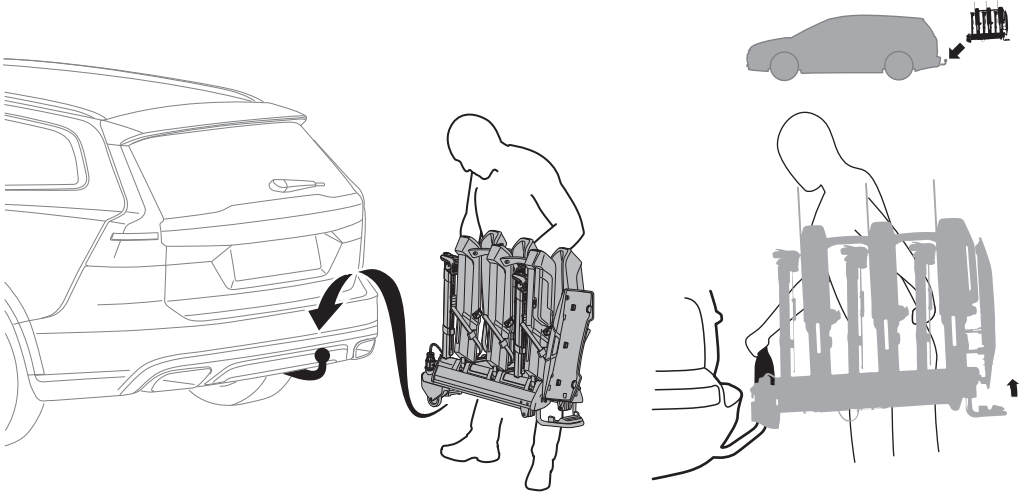

i

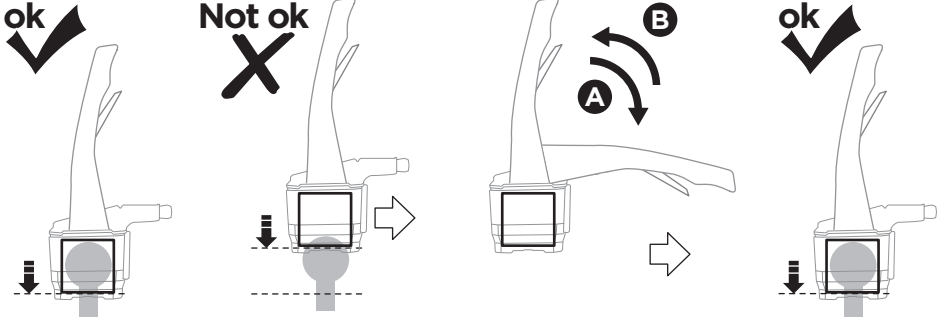

3

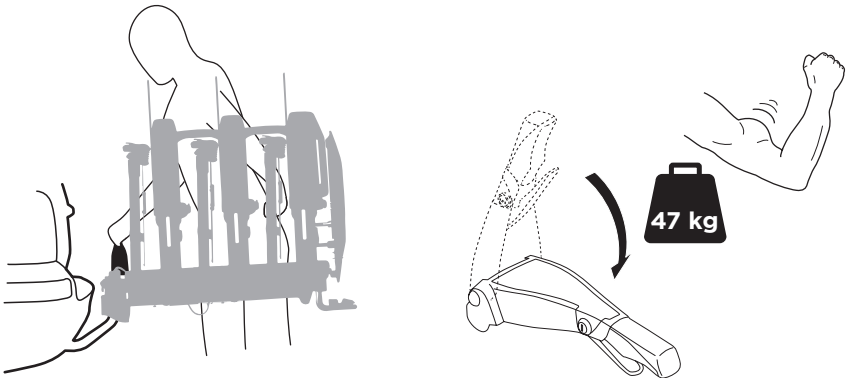

4

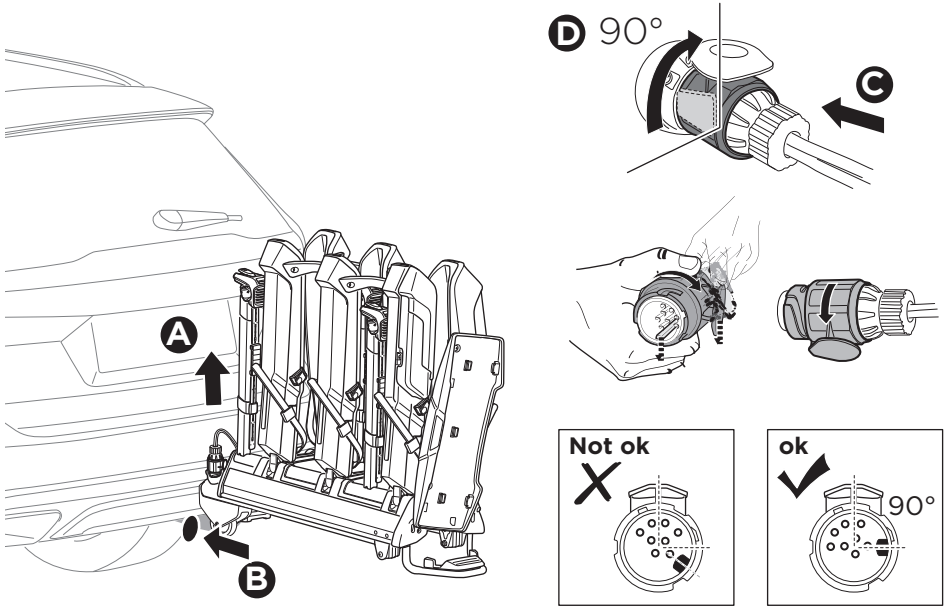

5

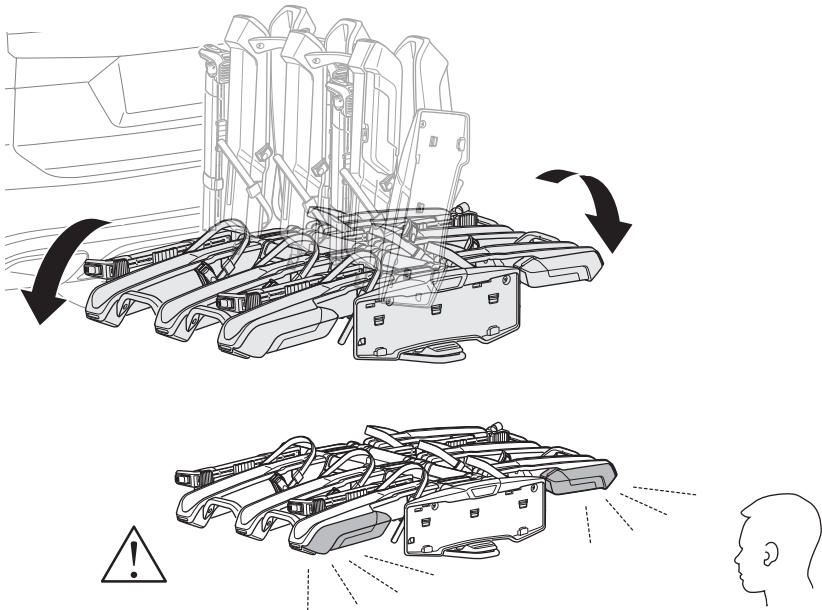

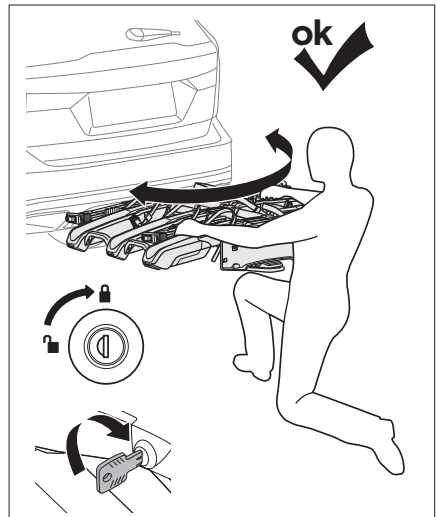
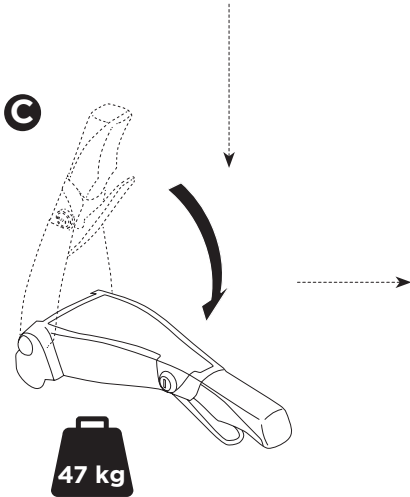
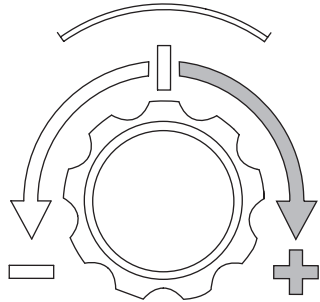
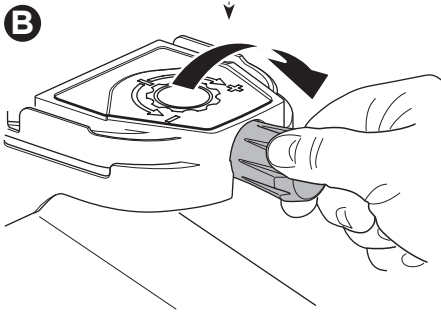
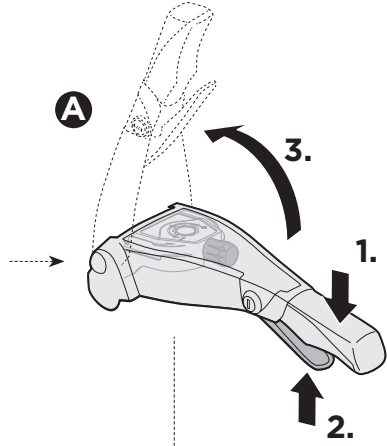

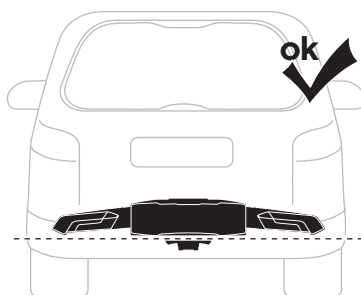
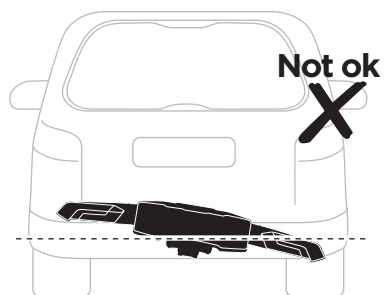
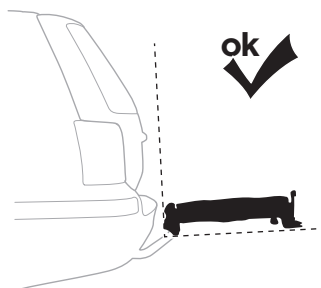
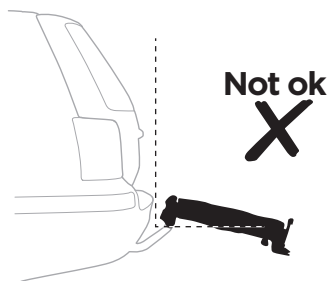

7

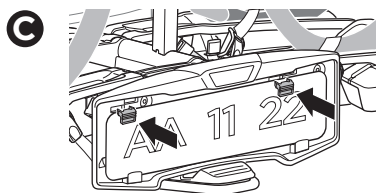
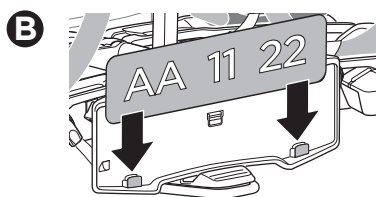
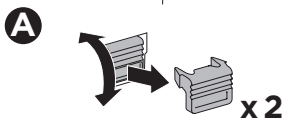
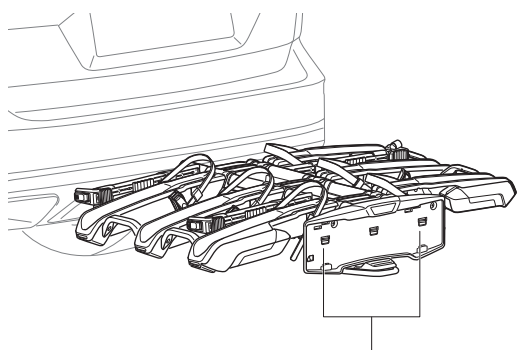

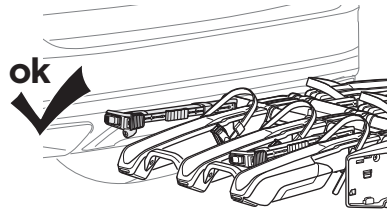
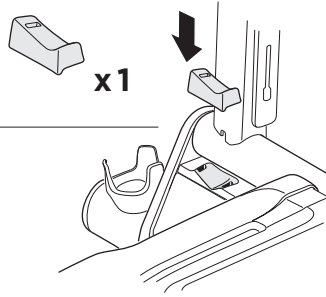
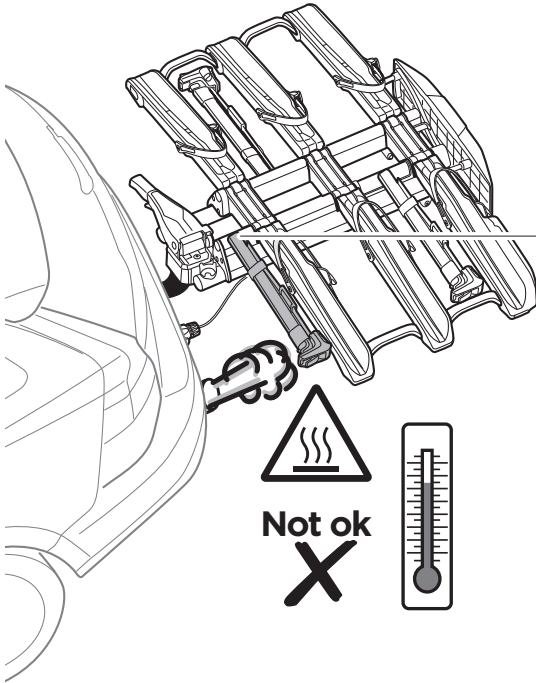

8

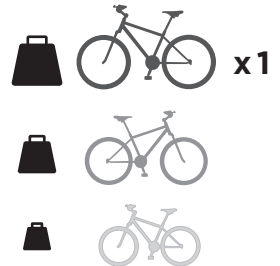
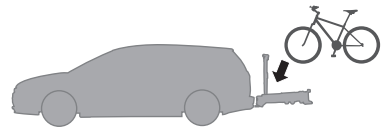
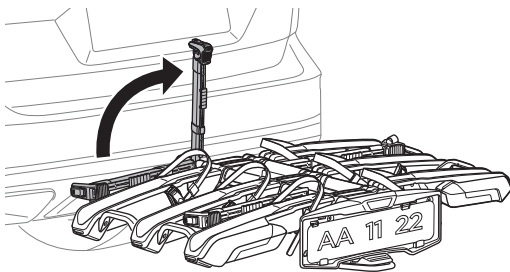

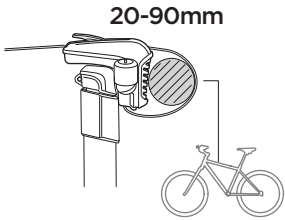

ok

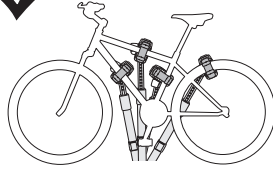

Not ok

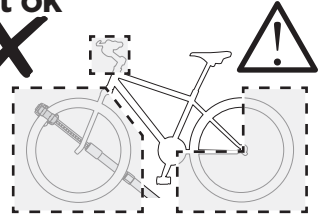

9

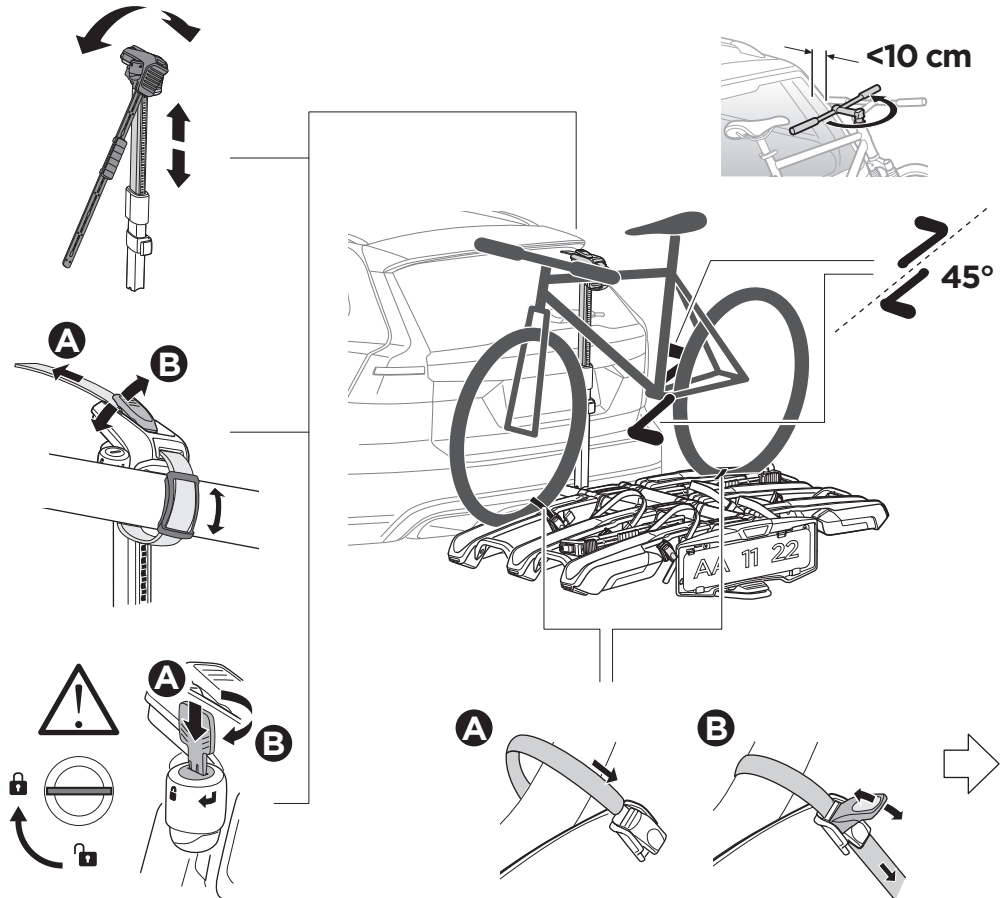

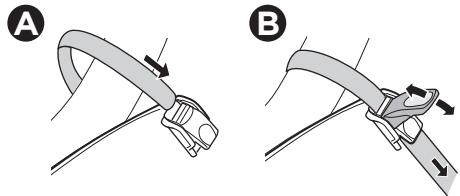
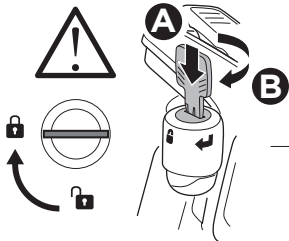
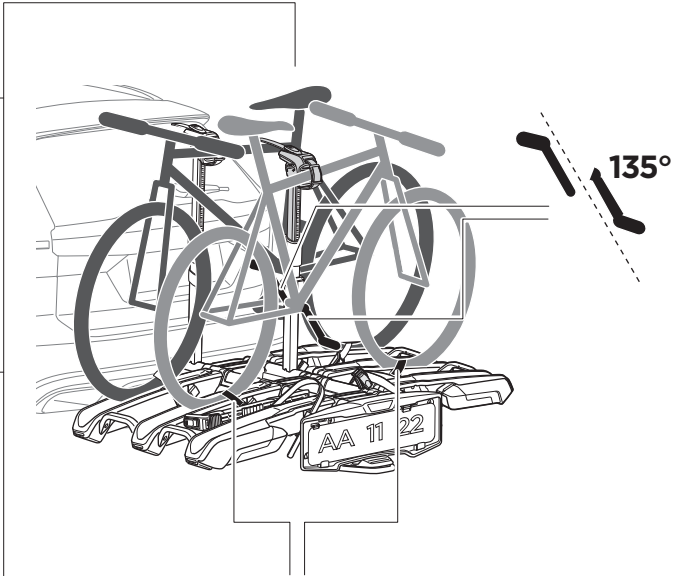
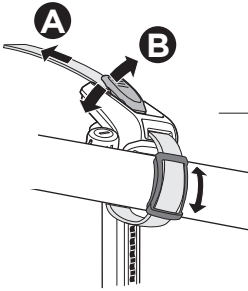
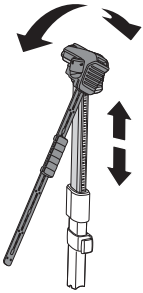
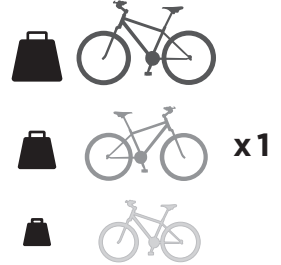
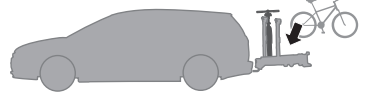
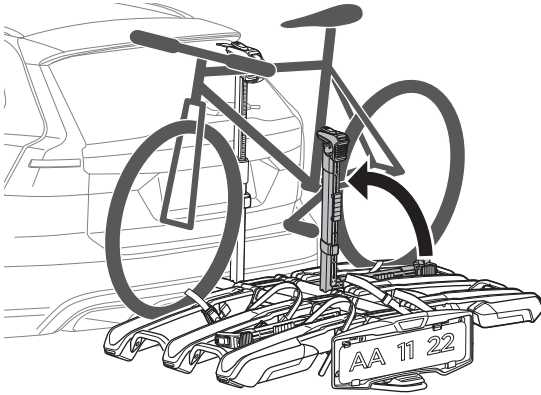

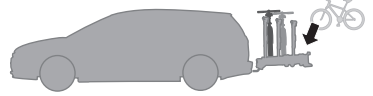
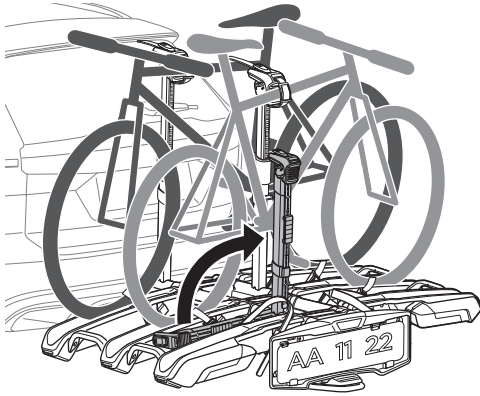

x1

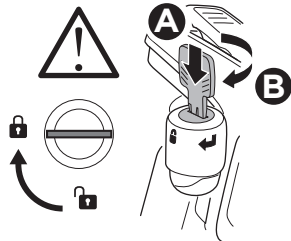
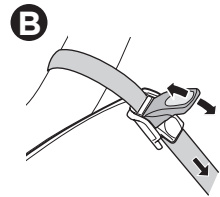
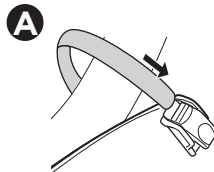
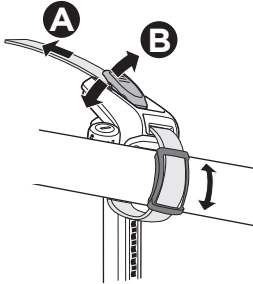
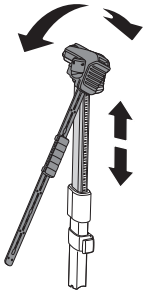

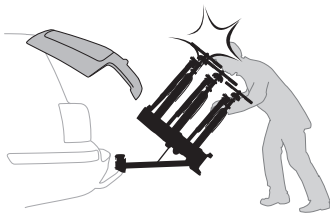
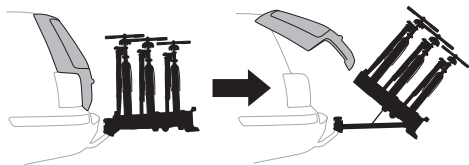

10

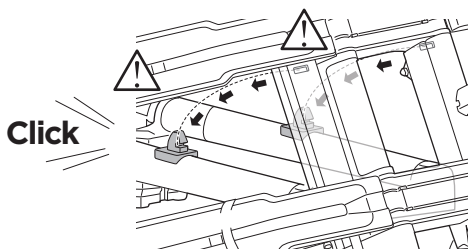
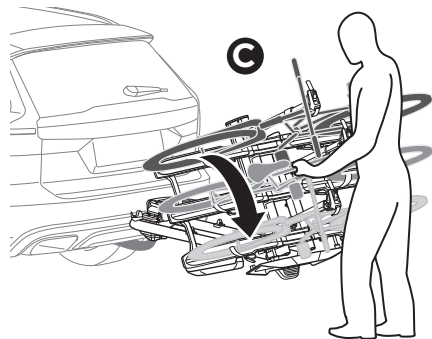
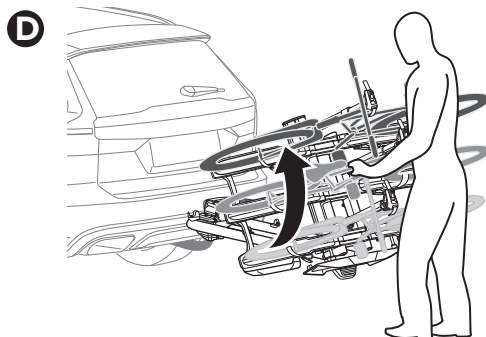
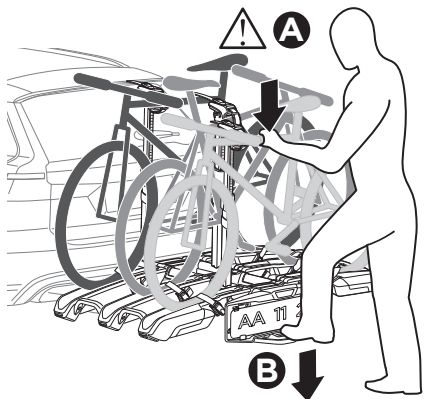

i

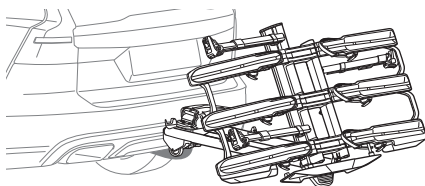
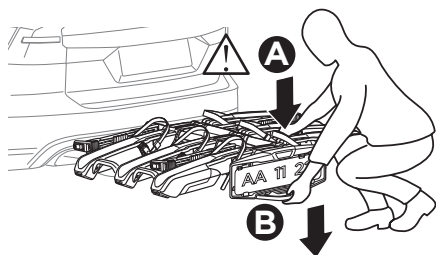

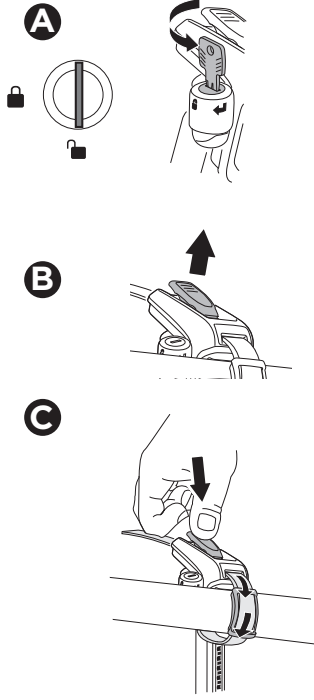
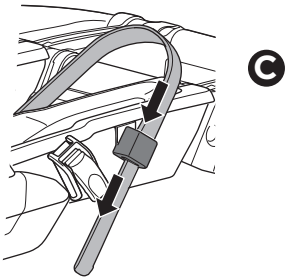
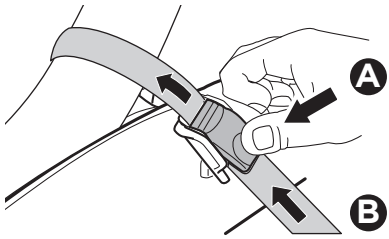
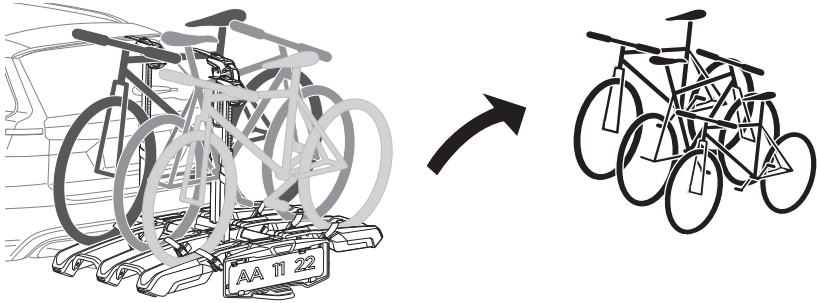

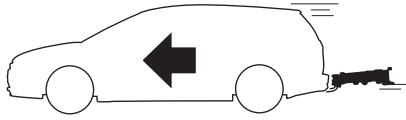

Not ok
X

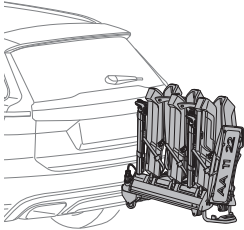

ok
✓

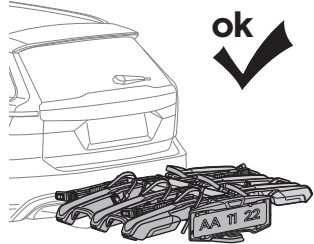

A

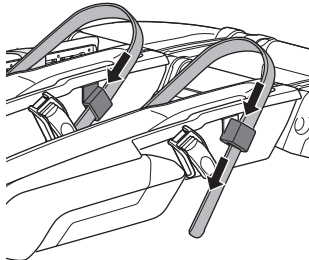

B

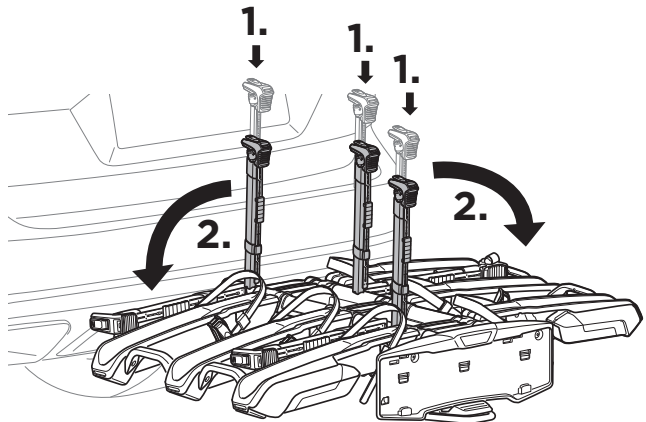
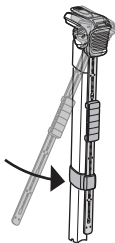



Not ok



ok

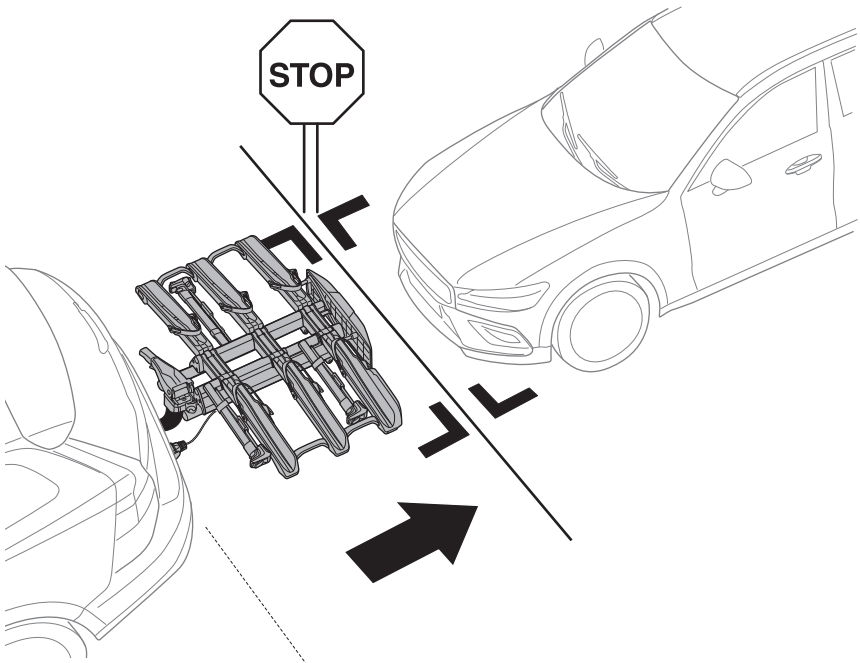
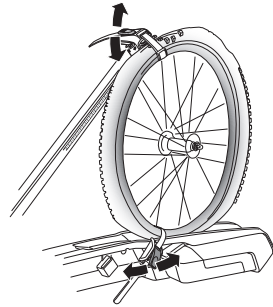

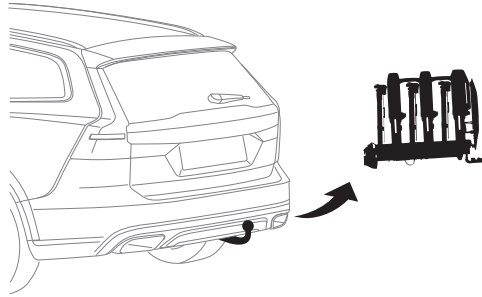

A

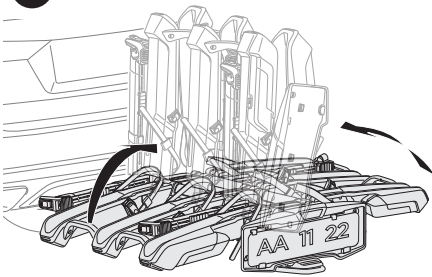

B

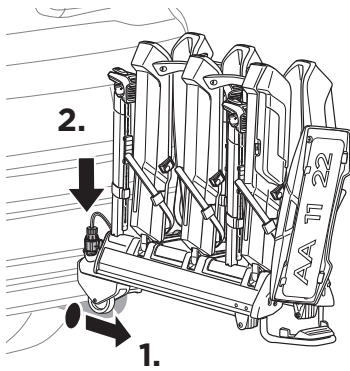

C

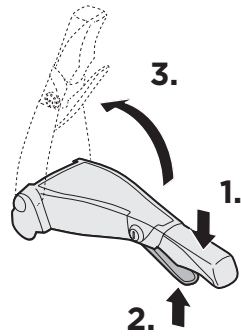

D

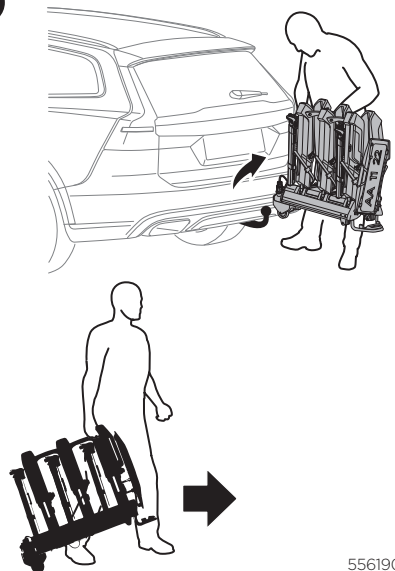

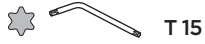

T 15

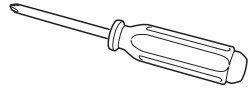

- 1: 12V H21W
- 2: 12V WY16W
- 3: 12V W16W

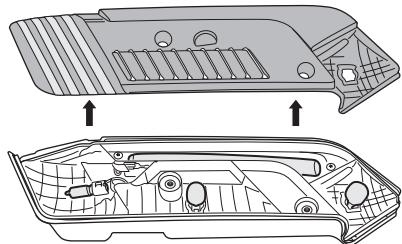
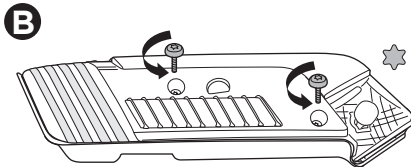
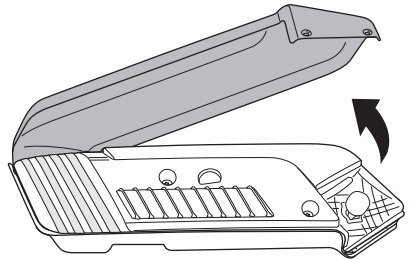
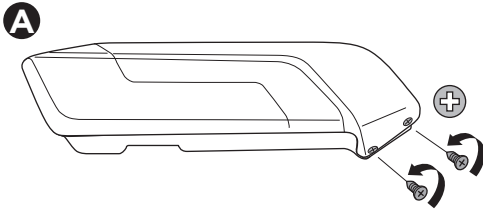
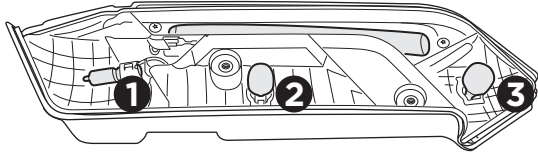

EN Accessories
 FR Accessoires
 ES Accesorios
 DE Zubehör
 NL Accessoires
 PT Acessórios
 IT Accessori
 SV Tillbehör
 DK Tilbehør
 NO Tilbehør
 FI Lisävarusteet
 IS Aukabúnaður

ET Tarvikud
 LV Piederumi
 LT Priedai
 RU Аксессуары
 UK Аксесуари
 PL Akcesoria
 CS Příslušenství
 HU Kiegészítők
 RO Accesorii
 SK Príslušenstvo
 SL Dodatna oprema
 BG Аксесоари





HR Dodatna oprema
 EL Αξεσουάρ
 TR Aksesuarlar
 MT Aċċessorji

אביזרים HE
 الملحقات AR

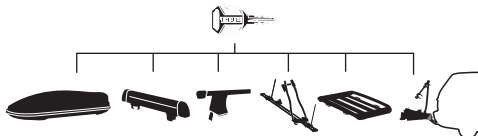
ZH (CN) 附件
 ZH (TR) 配件
 JA アクセサリー
 KO 액세서리
 TH อุปกรณ์เสริม
 MS Aksesori

Thule One-Key System



450400  (x4)
 450600  (x6)
 450800  (x8)
 451200  (x12)
 451600  (x16)

Thule Epos 3 Storage Bag

9793

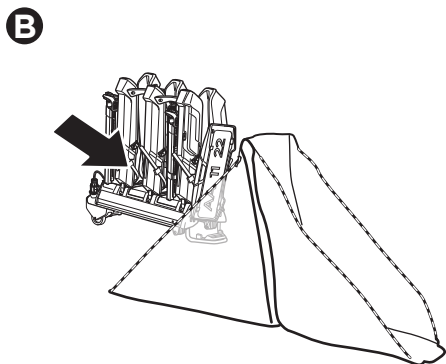
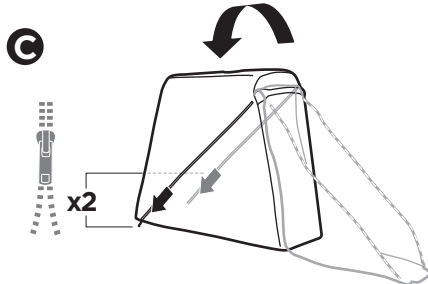
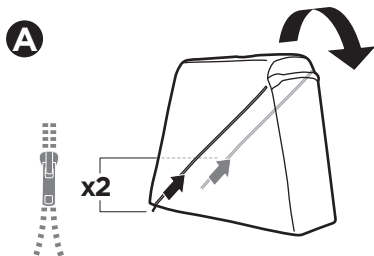

Thule Foldable Loading Ramp

9787



Thule Epos Bike Repair Holder

9783

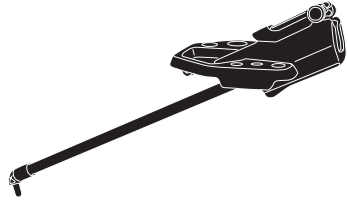

Thule High-Grade Lock

9785

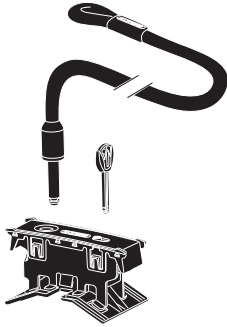

Thule 3rd Brake Light

9904

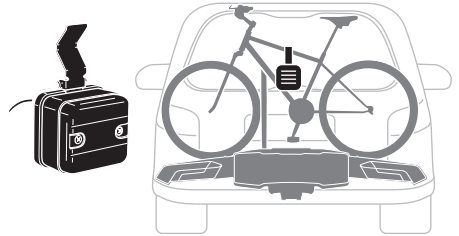

Thule Wheel Adapter

9772



Thule Adapter 9906

7-to-13-pin

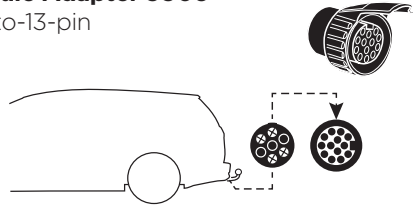

Thule XXL Fatbike Wheel Straps

985

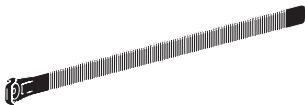

Thule Sweden AB

Borggatan 5
335 73 Hillerstorp, Sweden
info@thule.com
www.thule.com

© Thule Group Nov 2023. All rights reserved.

» PART OF THULE GROUP
5561905001