

DENON DJ

SC6000 PRIME

SC6000M PRIME

User Guide

English

Table of Contents

- Introduction 5**

- Box Contents 5**

- Support 5**
 - Product Registration5

- Setup 6**
 - 1. Assemble the Platter System (SC6000M PRIME only)..... 6**
 - 2. Connect and Start DJing! 6**

- Connection Diagrams 7**
 - Devices & File Analysis9
 - Networking9
 - Configuration9

- Features 10**
 - SC6000 PRIME 10**
 - Top Panel.....10
 - Media Selection & Browsing10
 - Playback & Transport Controls11
 - Sync & Pitch Controls11
 - Performance Controls.....12
 - Front Panel13
 - Rear Panel13

SC6000M PRIME	14
Top Panel.....	14
Media Selection & Browsing	14
Playback & Transport Controls	15
Sync & Pitch Controls.....	15
Performance Controls.....	16
Front Panel	17
Rear Panel	17
Operation.....	18
 Touchscreen Overview.....	18
Performance View.....	18
Library View	20
 Platter Display Overview (SC6000 PRIME only)	21
 Performing.....	22
Loading & Removing Tracks.....	22
Searching & Filtering Tracks	23
Editing Playlists.....	24
Playback & Cueing.....	25
Looping & Beat-Jumping.....	26
Syncing & Pitch Adjustment	26
Beat Grid Editing	27
Pad Modes	28
Hot Cue Mode.....	28
Loop Modes.....	28
Roll Mode.....	29
Slicer Mode	29

Control Center..... 30

- Parameters30
- User Profile31
- Settings.....34
- Source35
- Wi-Fi35
- Engine Lighting36
 - Preferences37

Appendix (English) 38

Technical Specifications 38

Trademarks & Licenses..... 39

Introduction

Thank you for purchasing your SC6000 or SC6000M PRIME hardware. At Denon DJ, we know how serious music is to you. That's why we design our equipment with only one thing in mind—to make your performance the best it can be. We're honored and excited to play a part in your musical & creative DJ journey!

Features:

- 10.1" HD multi-touch display with gesture support
- **SC6000 PRIME:** 8.5" jog wheel with tension adjust & HD color display
- **SC6000M PRIME:** 8.5" motorized platter with torque adjust & quick release vinyl
- 24-bit / 96kHz uncompromised digital audio output
- Built-in Wi-Fi and wired internet connectivity for music streaming
- Dual-layer playback with independent analog & digital outputs
- Plays uncompressed audio formats (FLAC, ALAC, WAV, AIFF)
- On-board analysis of music files & collection management
- Best-in-class time stretch and musical key change/sync algorithms
- Media inputs include: (3) USB, SD, and internal SATA drive bay
- Responsive rubber buttons and multi-function performance pads
- LAN output to link players and control pro DJ lighting and video
- Locking IEC connector for secured power cable

Box Contents

SC6000 PRIME/SC6000M PRIME

Platter Assembly (SC6000M PRIME only):

- Aluminum Platter
- Slipmat
- Control Disc with Quick Release Adapter (attached)

(2) RCA Audio Cables (stereo pairs)

USB Cable

USB Extension Cable

Networking Cable

Power Cable

Cleaning Cloth

Software Download Card

User Guide

Safety & Warranty Manual

Support

For the latest information about this product (documentation, technical specifications, system requirements, compatibility information, etc.) and product registration, visit denondj.com.

For additional product support, visit denondj.com/support.

Product Registration

Your product may include exclusive software and/or promotions which can only be accessed by registering your new product on the Denon DJ website.

To check eligibility and access the available content, please register your product by following the instructions below:

1. Visit denondj.com and click **Account**.
2. Click **Sign In** to access your existing account, or create a new account.
3. Once signed in, click **Register New Product**.
4. Enter the product serial number into the box and click **Check Serial**.
5. Complete the form and click **Register Your Product**.
6. Upon successful registration, any applicable software downloads, exclusive content, and promotional offers will be shown in your account.

Setup

1. Assemble the Platter System (SC6000M PRIME only)

1. Remove the SC6000M PRIME base from the packaging. Remove the platter assembly from the package. Place SC6000M PRIME on a flat, stable surface for assembly and operation.
2. Place the platter onto the SC6000M PRIME base by aligning the pins in the bottom of the platter with the holes in SC6000M PRIME's motor. Press it down firmly. Check to make sure that it rotates uniformly and does not wobble excessively.
3. Place the slipmat onto the platter. Then place the **Control Disc** over the spindle (with the attached **Quick Release Adapter** on top). To lock the **Control Disc** to the spindle, pinch the top of the spindle while slowly rotating the disc until you hear it click. It locks when the groove in the spindle lines up directly opposite to the button on the side of the **Quick Release Adapter**.

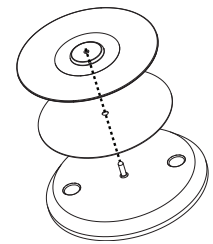
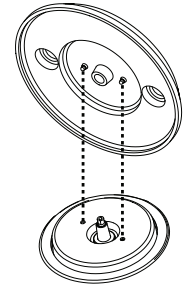

2. Connect and Start DJing!

Important: Occasionally, we may update the PRIME hardware's firmware to add exciting new features and improvements. Visit denondj.com/downloads to check for available firmware updates, especially after you update your software (firmware updates may address new software features).

1. Visit enginejdj.com/downloads to download the Engine DJ software.
2. Double-click the **.exe** (Windows®) or **.dmg** (macOS®) installer file you downloaded, and then follow the on-screen instructions to install Engine DJ.
3. Make sure all of your devices are powered **off** or all of their volume levels are at their **minimum** positions.
4. Connect the PRIME hardware's audio outputs (**Layer A/B** or **Digital Outputs A/B**) to the inputs of your mixer.
5. Connect the PRIME hardware's **Link** ports according to one of the following connection diagram examples.
6. Connect any output devices (headphones, power amplifiers, loudspeakers, etc.) to the outputs of your mixer.
7. Connect all of your devices to power sources.
 - When starting a session, power on **(1)** the PRIME hardware and other input sources, **(2)** your mixer, and then **(3)** output devices.
 - When ending a session, power off **(1)** output devices, **(2)** your mixer, and then **(3)** the PRIME hardware and other input sources.
8. **To use EngineOS** (standalone playback): Insert a USB flash drive or SD card (with an Engine-configured music library) to one of the PRIME hardware's **USB ports** or **SD Card Slot**.

Connection Diagrams

Items shown but not listed under **Box Contents** are sold separately.

Example 1

This example shows 2 PRIME hardware units with their **Link** ports connected to each other directly.

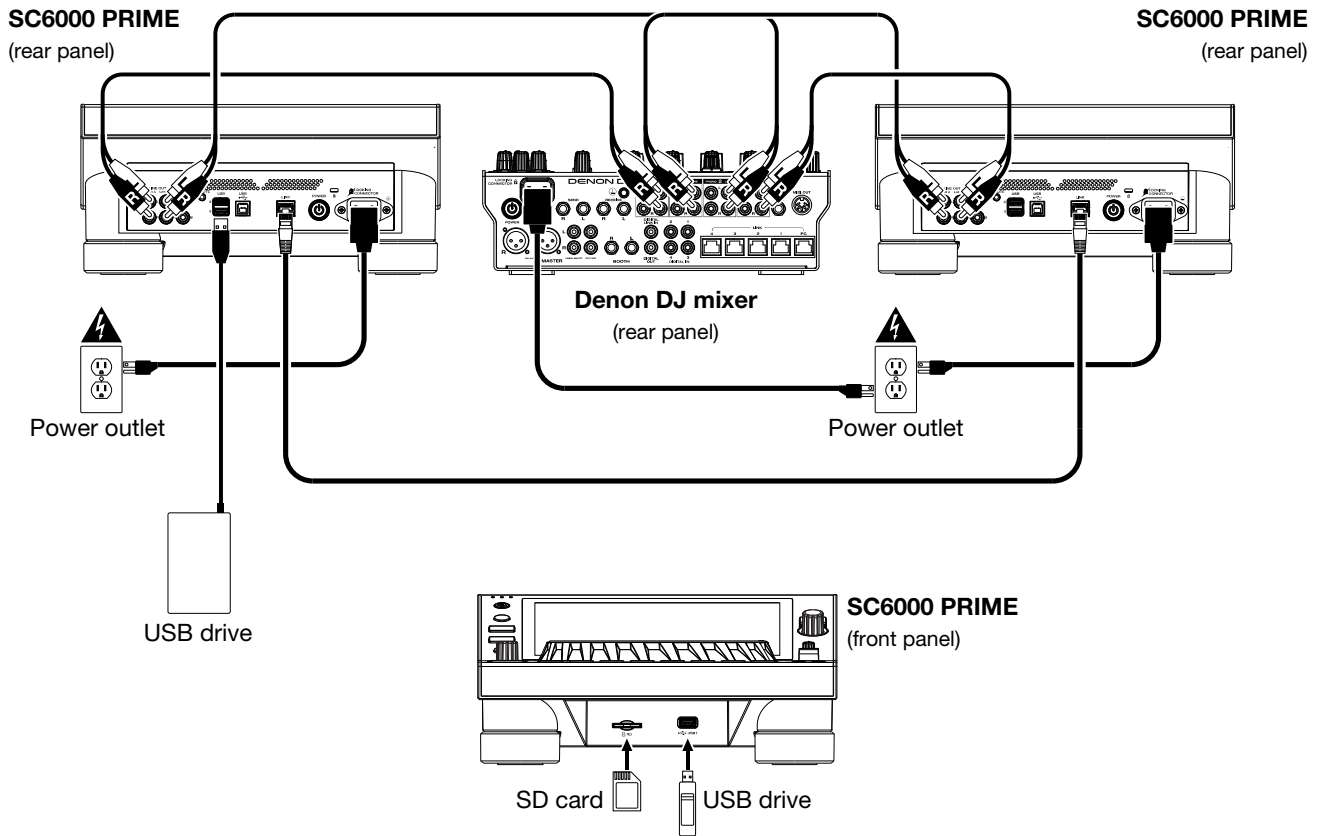

Example 2

This example shows 4 the PRIME hardware units with their **Link** ports connected to **Link Ports 1-4** of a Denon DJ mixer. All 4 units are networked through the mixer.

Note: If you are using a different mixer with this setup, connect the **Link** ports of all 4 PRIME hardware units to an Ethernet hub instead of to the mixer.

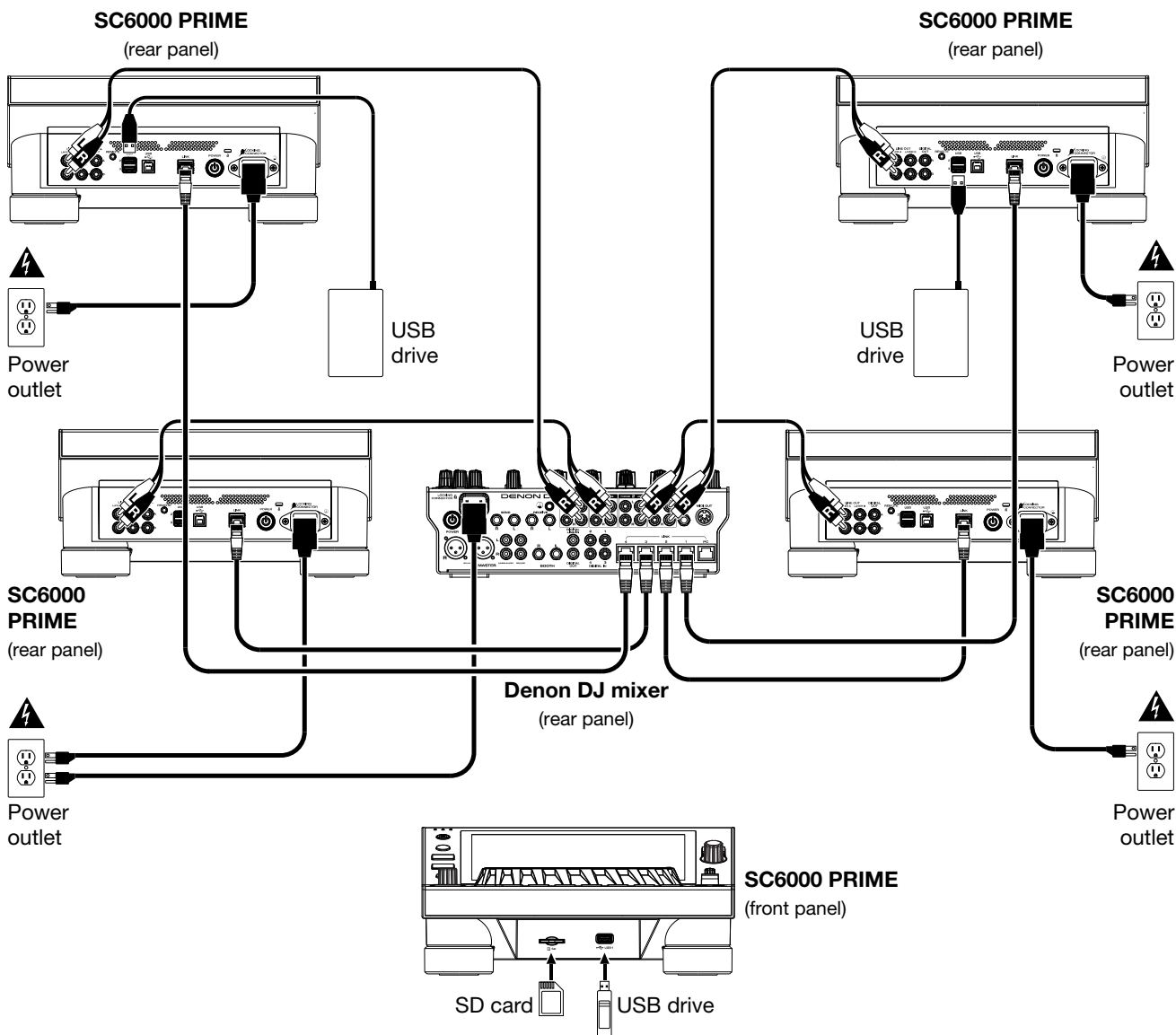

RF Warning: This is a mobile device. Maintain a distance of at least 8 inches / 20 centimeters of separation between the transmitter's radiating structure(s) and your body or other people nearby.

Devices & File Analysis

PRIME hardware can play music files from USB drives, SD cards, or other connected PRIME hardware units. Make sure you are using only the supported file systems (for USB drives or SD cards) and file formats (for music files) listed below.

Supported file systems:	exFAT (recommended), FAT32	
Supported file formats:	AAC/M4A	MP3 (32–320 kbps)
	AIF/AIFF (44.1–192 kHz, 16–32-bit)	MP4
	ALAC	Ogg Vorbis
	FLAC	WAV (44.1–192 kHz, 16–32-bit)

Although PRIME hardware can play tracks that have not been analyzed yet, pre-analyzing them allows its features to work most effectively. You can analyze tracks in one of two ways:

- **On the PRIME hardware, load the track:** When you load a track to play, PRIME hardware will automatically analyze it (if it has not already been analyzed). This may take a moment to complete, depending on the length of the track. You can start playing the track from the beginning **immediately**, though you will need to wait a moment for the analysis to finish.
- **Use Engine DJ software:** The included Engine DJ software can pre-analyze your music library to use with the PRIME hardware. You can also use it to organize your library, manage your PRIME hardware preferences, etc. (see [Operation](#) to learn more about this).

Visit enginedj.com/downloads to download the Engine DJ software.

To eject a USB drive or SD card:

1. Make sure none of its tracks are being played on any connected PRIME hardware units.
2. Press **Media Eject**. A list of connected devices will appear in the touchscreen.
3. Tap the **Eject** icon on the touchscreen next to the name of your device. If a track on the device is currently playing, you will be asked if you want to continue ejecting, which will stop the track. Tap **Cancel** to cancel ejecting the device, or tap **OK** to eject it.

To eject additional devices, repeat Step 3.

To return to the previous screen, press **Media Eject** again, or tap the **X** in the upper-right corner.

Networking

You can network up to four PRIME hardware units together, enabling them to share track databases, timing and BPM information, and other data seamlessly over this connection.

This feature provides many advantages while performing. For instance, if you are using four PRIME hardware units, you can use one of them to browse through **all** tracks on **all** devices (USB drives or SD cards) connected to **any** of those the PRIME hardware units. You can then play any of those tracks immediately without having to move a device from one unit to the other.

To network PRIME hardware units together, use the included networking cables to do one of the following:

- If you are using only two PRIME hardware units, connect their two **Link** ports.
- If you are using two or more PRIME hardware units, connect each of their **Link** ports to a **Link** port (1–4) on your Denon DJ mixer.
- If you are using two or more PRIME hardware units, connect each of their **Link** ports to an Ethernet port on a router.

The **Link** light will turn on when the PRIME hardware unit is properly connected to a network.

Configuration

Your PRIME hardware has several settings that you can customize in the [User Profile](#) and [Settings](#) menus. See [Control Center](#) to learn about these settings.

Features

SC6000 PRIME

Top Panel

Media Selection & Browsing

1. **Touchscreen:** This full-color, multi-touch display shows information relevant to SC6000 PRIME's current operation. Touch the display (and use the hardware controls) to control the interface. See [Touchscreen Overview](#) for more information.
2. **Media Selection:** These lights will illuminate to indicate if the corresponding type of media is connected: **USB**, **SD**, or **Link**.

3. **Source:** Press this button to show a list of devices connected to SC6000 PRIME in the touchscreen (other networked SC6000 PRIME units, USB drives, SD card, Wi-Fi, etc.). Tap a device in the list to select it.

4. **Media Eject:** Press this button to show a list of devices connected to that SC6000 PRIME unit in the **touchscreen** (i.e., USB drives connected to its USB ports or an SD card inserted into its SD card slot).

To eject a device, make sure none of its tracks are being played, and then tap the **Eject** icon on the **touchscreen** and follow the prompts.

5. **Back:** While in Library View, press this button to move to the previous window. While in Performance View, press this button to enter Library View.
6. **Forward:** While in Library View, press this button to move to the next window. While in Performance View, press this button to enter Library View.

7. **Select/Zoom:** While in Library View, turn this knob to scroll through a list, and press the knob to select an item or load a track to the layer in focus. Double-press the knob to load a track to both layers ("instant doubles").

While in Performance View, turn this knob to zoom in and out of a track's waveform. Press and hold the knob to adjust the beat grid (see [Performance View](#) for more details on adjusting the beat grid).

Press and hold **Shift** and then press and hold this knob to manually adjust cue/loop point locations left or right using the **touchscreen** controls.

8. **View / Preferences/Utility:** Press this button to switch between Library View and Performance View. Double-press this button to enter the Engine Lighting view. Press and hold this button to enter the User Profile menu.

Press and hold **Shift** and press this button to toggle between viewing single layer or dual layer waveforms on the **touchscreen**. You can also press and hold **Shift** and then press and hold this button to swap deck positions.

9. **Shortcuts:** Press this button to open the [Control Center](#), which includes quick links to other menus such as Source, User Profile and Settings.

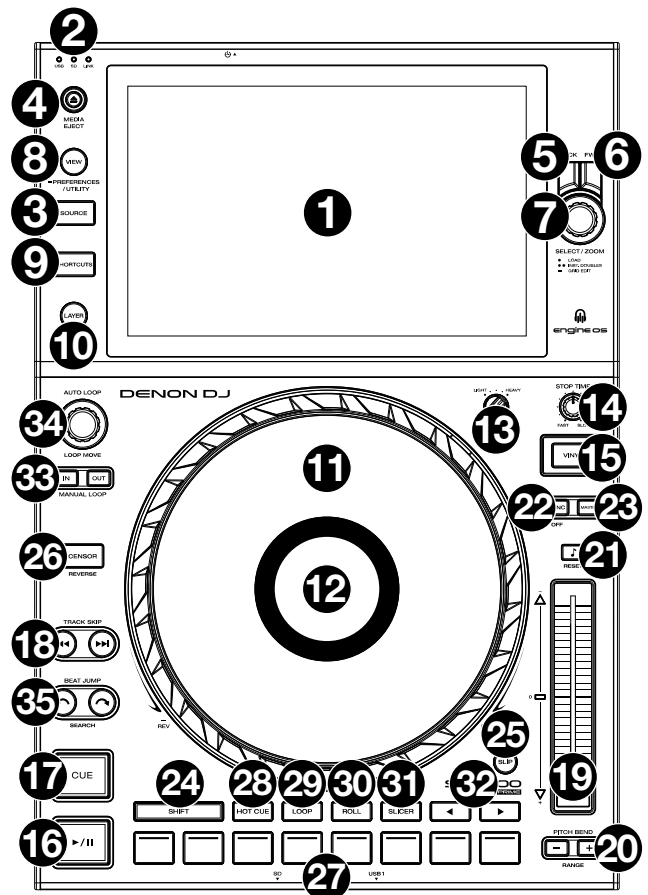

Playback & Transport Controls

10. **Layer:** Press this button to switch the layer focus of the SC6000 PRIME.
11. **Platter:** This capacitive, touch-sensitive platter controls the audio playhead when the wheel is touched and moved. When the **Vinyl** button is on, move the **platter** to “scratch” the track as you would with a vinyl record. When the **Vinyl** button is off (or if you are touching only the side of the **platter**), move the **platter** to temporarily adjust the track’s speed.
12. **Platter Display:** This display shows information relevant to the performance, including the current playhead position and auto loop size, as well as album artwork. See [Platter Display Overview](#) for more information.
13. **Wheel Adjust:** Turn this knob to set how resistant the platter is to adjustments. This knob applies a brake to the platter to prevent unintentional drifting due to environmental vibrations from bass frequencies, surface instability, etc.
14. **Stop Time:** Controls the rate at which the track slows to a complete stop (“brake time”) when you pause it by pressing **Play/Pause** (▶/||).
15. **Vinyl:** Press this button to activate/deactivate a “vinyl mode” for the platter. When activated, you can use the **platter** to “scratch” the track as you would with a vinyl record.
16. **Play/Pause** (▶/||): This button pauses or resumes playback.
Press and hold **Shift** and then press this button to “stutter-play” the track from the initial cue point.
17. **Cue:** During playback, press this button to return the track to the initial cue point and stop playback. (To move the initial cue point, make sure the track is paused, move the **platter** to place the audio playhead at the desired location, and then press this button.) If the deck is paused, press and hold this button to temporarily play the track from the initial cue point. Release the button to return the track to the initial cue point and pause it. To continue playback without returning to the initial cue point, press and hold this button and then press and hold the **Play** button, and then release both buttons.
During playback, press and hold **Shift** and press this button to set the initial cue point at the current playhead position.
18. **Track Skip:** Press either of these buttons to skip to the previous or next track.
Press the **Previous Track** button in the middle of a paused track to return to the beginning of the track.
Press and hold **Shift** and then press one of these buttons to search backward or forward through the track.

Sync & Pitch Controls

19. **Pitch Fader:** Move this fader to adjust the speed (pitch) of the track. You can adjust its total range by pressing and holding **Shift** and pressing one of the **Pitch Bend** buttons.
Important: If Sync is activated, moving the pitch fader on the “primary” SC6000 PRIME unit will change the speed of all synced units, while moving the pitch fader on other units will do nothing.
20. **Pitch Bend** –/+ : Press and hold one of these buttons to momentarily reduce or increase (respectively) the speed of the track.
Press and hold **Shift** and then press one of these buttons to set the range of the pitch fader.
21. **Key Lock/Reset:** Press this button to activate or deactivate Key Lock. When Key Lock is activated, the track’s key will remain the same even if you adjust its speed.
Press and hold **Shift** and press this button to reset the track to its original key regardless of the position of the **pitch fader** or edits made via key change menu.
22. **Sync/Sync Off:** Press this button to activate Sync.
To sync two or more PRIME units, press **Sync** on the unit that you want to control the BPM, which becomes the “primary.” After Sync is activated on that unit, press **Sync** on any additional units. The tempo of each unit will immediately synchronize to match the tempo of the primary unit.
To deactivate Sync, press the **Sync** button again, or press and hold **Shift** and press **Sync**, depending on the **Sync Button Action** setting in the [User Profile](#) menu.
23. **Master:** Press this button to set this SC6000 PRIME unit as the one that controls the lead tempo. All connected units with Sync activated will use this tempo. If you stop the sync lead unit, the next-longest-playing unit in the setup will automatically become the new sync lead (unless you change it manually).

Performance Controls

24. **Shift:** Press and hold this button to access secondary functions of other controls.
25. **Slip:** Press this button to enable or disable Slip Mode. In Slip Mode, you can jump to cue points, use the platter, or pause the track while the track's timeline continues (the lower half of the waveform in the display will continue moving forward). In other words, when you stop whatever action you are performing, the track will resume normal playback from where it would have been if you had never done anything (i.e., as if the track had been playing forward the whole time).
26. **Censor/Reverse:** Press this button to activate or deactivate the Censor feature: the playback of the track will be reversed, but when you release the button, normal playback will resume from where it would have been if you had never engaged the Censor feature (i.e., as if the track had been playing forward the whole time).
Press and hold **Shift** and then press this button to reverse the playback of the track normally. Press this button again to return playback to the normal forward direction.
27. **Performance Pads:** These pads have different functions depending on the current pad mode. See [Pad Modes](#) for more information.
28. **Hot Cue:** Press this button to enter Hot Cue Mode.
29. **Loop:** Press this button once to enter Manual Loop Mode, and press it again to enter Auto Loop Mode.
30. **Roll:** Press this button to enter Roll Mode.
31. **Slicer:** Press this button once to enter Slicer Mode, and press it again to enter Slicer Loop Mode.
32. **Parameter ◀/▶:** Use these buttons for various functions in each Pad Mode. See [Pad Modes](#) for more information.
33. **Loop In/Loop Out:** Press either of these buttons to create a Loop In or Loop Out point at the current location. Their placement will be affected by the **Quantize** and **Smart Loops** settings. See [Control Center](#) for more information.
34. **Auto Loop/Loop Move:** Turn this knob to set the size of an automatic loop. The value will be shown in the touchscreen and platter display.
Press this knob to activate or deactivate an automatic loop at the current location of the track.
Tip: You can assign auto loops to pads in Manual Loop Mode. See [Pad Modes](#) for more information.
Press and hold **Shift** and turn this knob to shift the active loop to the left or right.
35. **Beat Jump:** Press either of these buttons to skip backward or forward through the track.
Press and hold **Shift** and then press one of these buttons to increase or decrease the beat jump size.

Front Panel

1. **Front USB Port:** Connect a standard USB drive to this USB port. When you select that USB drive as a source (press the **Source** button), you can use the display to select and load tracks from your USB drive. There are also two similar USB ports on the rear panel. You can use the included USB extension cable to accommodate larger or smaller USB thumb drives.
2. **SD Card Slot:** Insert a standard SD card to this slot. When you select that SD card as a source (press the **Source** button), you can use the display to select and load tracks from your SD card.

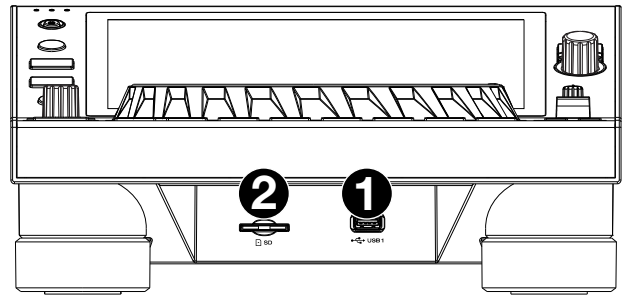

Rear Panel

1. **Power Input:** Use the included locking power cable to connect this input to a power outlet. To remove the power cable, push down on the yellow tab and then pull the cable out of the input. You can also use a standard IEC power cable in place of the included locking power cable.
SC6000 PRIME has a protection circuit to safely eject all media after an unexpected power loss to protect your data from corruption. Reconnect your power source to return to normal operation.

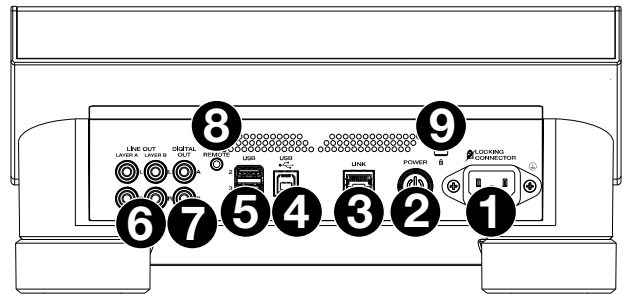

2. **Power Button:** Press this button to power SC6000 PRIME on or off. Power on SC6000 PRIME only **after** you have connected all of your input devices and **before** you power on your amplifiers and loudspeakers. Power off your amplifiers and loudspeakers **before** powering off SC6000 PRIME.
Press and hold this button for 10 seconds to reset SC6000 PRIME.
3. **Link Port:** Use the included networking cable to connect this port to another SC6000 PRIME or to your Denon DJ mixer. Each networked SC6000 PRIME can share track databases, timing and BPM information, and other track data over this connection.
4. **USB B Port:** Use a standard USB cable (included) to connect this USB port to an available USB port on your computer. This connection sends and receives MIDI messages to and from the computer.
5. **Rear USB Ports 2/3:** Connect standard USB drives to these USB ports. When you select one of those USB drives as a source (press the **Source** button), you can use the display to select and load tracks from your USB drives. There is also a similar USB port on the front panel.
6. **Layer A/B Outputs:** Use standard RCA cables to connect these outputs to your DJ mixer. The **Layer A** Line Outputs send out the audio signal from Layer A. The **Layer B** Line Outputs send out the audio signal from Layer B.
7. **Digital Outputs A/B:** Use standard digital coaxial cables to connect these 24-bit/96 kHz outputs to devices and mixers such as the Denon DJ X1850 PRIME.
8. **Remote Input:** Use a standard remote start cable to connect this input to the remote-start output of your mixer (if available). While connected to a remote-start-compatible mixer, moving the crossfader toward the side that corresponds to this SC6000 PRIME (or raising the channel fader for its channel) will automatically start the track on the currently selected layer.
9. **Kensington® Lock Slot:** Use this slot to secure SC6000 PRIME to a table or other surface.

SC6000M PRIME

Top Panel

Media Selection & Browsing

- Touchscreen:** This full-color multi-touch display shows information relevant to SC6000M PRIME's current operation. Touch the display (and use the hardware controls) to control the interface. See [Touchscreen Overview](#) for more information.
- Media Selection:** These lights will illuminate to indicate if the corresponding type of media is connected: **USB**, **SD**, or **Link**.
- Source:** Press this button to show a list of available devices connected to SC6000M PRIME in the touchscreen (other networked SC6000M PRIME units, USB drives, SD card, Wi-Fi, etc.). Tap a device in the list to select it.

- Media Eject:** Press this button to show a list of devices connected to that SC6000M PRIME unit in the **touchscreen** (i.e., USB drives connected to its USB ports or an SD card inserted into its SD card slot).

To eject a device, make sure none of its tracks are being played, and then tap the **Eject** icon on the **touchscreen** and follow the prompts.

- Back:** While in Library View, press this button to move to the previous window. While in Performance View, press this button to enter Library View.
- Forward:** While in Library View, press this button to move to the next window. While in Performance View, press this button to enter Library View.

- Select/Zoom:** While in Library View, turn this knob to scroll through a list, and press the knob to select an item or load a track to the layer in focus. Double-press the knob to load a track to both layers ("instant doubles").

While in Performance View, turn this knob to zoom in and out of a track's waveform. Press and hold the knob to adjust the beat grid (see [Performance View](#) for more details on adjusting the beat grid).

Press and hold **Shift** and then press and hold this knob to manually adjust cue/loop point locations left or right using the **touchscreen** controls.

- View / Preferences/Utility:** Press this button to switch between Library View and Performance View. Double-press this button to enter the Engine Lighting view. Press and hold this button to enter the User Profile menu.

Press and hold **Shift** and press this button to toggle between viewing single layer or dual layer waveforms on the **touchscreen**. You can also press and hold **Shift** and then press and hold this button to swap deck positions.

- Shortcuts:** Press this button to open the [Control Center](#), which includes quick links to other menus such as Source, User Profile and Settings.

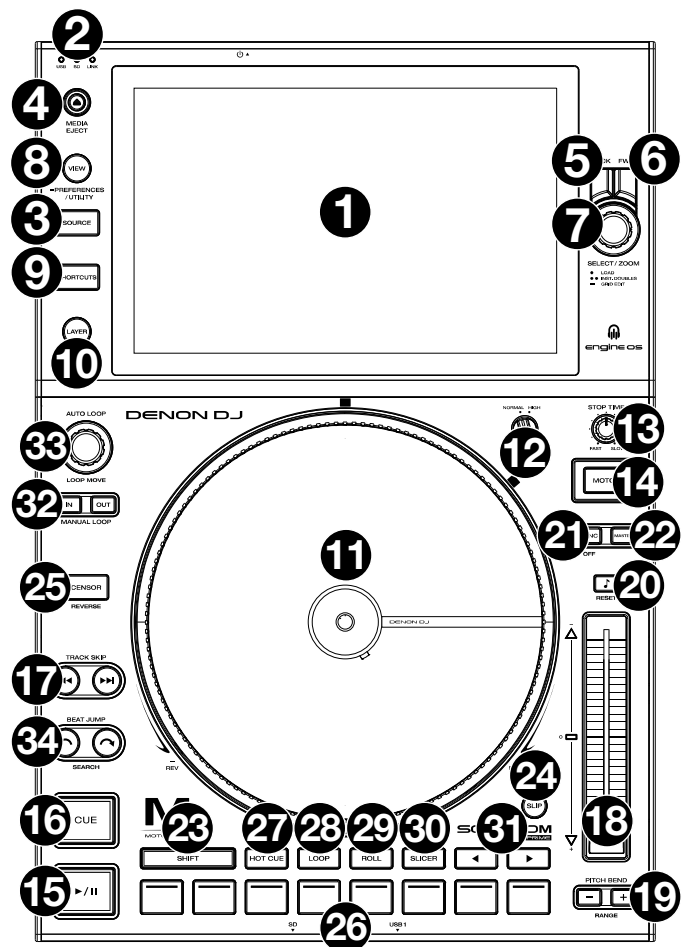

Playback & Transport Controls

10. **Layer:** Press this button to switch the layer focus of the SC6000M PRIME.
11. **Platter:** This motorized platter controls the audio playhead in the software. It can be used to scratch and spin or act as a static pitch platter depending on the setting of the **Motor** button.
12. **Torque Adjust:** Flip this rotary switch to adjust the torque of the **platters**. At the **high** setting, the platters will have the heavier, stronger feel of “modern” turntables. At the **normal** setting, they are lighter and more graceful—the feel of a “classic” turntable.
13. **Stop Time:** Controls the rate at which the track slows to a complete stop (“brake time”) when you pause it by pressing **Play/Pause** (▶/||).
14. **Motor:** Press this button to activate or deactivate the platter motor. When the motor is activated, the platter will spin and scratch like a turntable.
When the motor is deactivated and audio is playing, move the **platter** to temporarily adjust the track’s speed, which is useful for beat alignment. When deactivated and audio is paused, move the **platter** to scratch the track. Audio will not be interrupted if the motor is activated during playback.
15. **Play/Pause** (▶/||): This button pauses or resumes playback.
Press and hold **Shift** and then press this button to “stutter-play” the track from the initial cue point.
16. **Cue:** During playback, press this button to return the track to the initial cue point and stop playback. (To move the initial cue point, make sure the track is paused, move the **platter** to place the audio playhead at the desired location, and then press this button.) If the deck is paused, press and hold this button to temporarily play the track from the initial cue point. Release the button to return the track to the initial cue point and pause it. To continue playback without returning to the initial cue point, press and hold this button and then press and hold the **Play** button, and then release both buttons.
During playback, press and hold **Shift** and press this button to set the initial cue point at the current playhead position.
17. **Track Skip:** Press either of these buttons to skip to the previous or next track.
Press the **Previous Track** button in the middle of a paused track to return to the beginning of the track.
Press and hold **Shift** and then press one of these buttons to search backward or forward through the track.

Sync & Pitch Controls

18. **Pitch Fader:** Move this fader to adjust the speed (pitch) of the track. You can adjust its total range by pressing and holding **Shift** and pressing one of the **Pitch Bend** buttons.
Important: If Sync is activated, moving the pitch fader on the “primary” SC6000M PRIME unit will change the speed of all synced units, while moving the pitch fader on other units will do nothing.
19. **Pitch Bend –/+:** Press and hold one of these buttons to momentarily reduce or increase (respectively) the speed of the track.
Press and hold **Shift** and then press one of these buttons to set the range of the pitch fader.
20. **Key Lock/Reset:** Press this button to activate or deactivate Key Lock. When Key Lock is activated, the track’s key will remain the same even if you adjust its speed.
Press and hold **Shift** and press this button to reset the track to its original key regardless of the position of the **pitch fader** or edits made via key change menu.
21. **Sync/Sync Off:** Press this button to activate Sync.
To sync two or more PRIME units, press **Sync** on the unit that you want to control the BPM, which becomes the “primary.” After Sync is activated on that unit, press **Sync** on any additional units. The tempo of each unit will immediately synchronize to match the tempo of the primary unit.
To deactivate Sync, press the **Sync** button again, or press and hold **Shift** and press **Sync**, depending on the **Sync Button Action** setting in the [User Profile](#) menu.
22. **Master:** Press this button to set this SC6000M PRIME unit as the one that controls the lead tempo. All connected units with Sync activated will use this tempo. If you stop the sync lead unit, the next-longest-playing unit in the setup will automatically become the new sync lead (unless you change it manually).

Performance Controls

23. **Shift:** Press and hold this button to access secondary functions of other controls.
24. **Slip:** Press this button to enable or disable Slip Mode. In Slip Mode, you can jump to cue points, use the platter, or pause the track while the track's timeline continues (the lower half of the waveform in the display will continue moving forward). In other words, when you stop whatever action you are performing, the track will resume normal playback from where it would have been if you had never done anything (i.e., as if the track had been playing forward the whole time).
25. **Censor/Reverse:** Press this button to activate or deactivate the Censor feature: the playback of the track will be reversed, but when you release the button, normal playback will resume from where it would have been if you had never engaged the Censor feature (i.e., as if the track had been playing forward the whole time).
Press and hold **Shift** and then press this button to reverse the playback of the track normally. Press this button again to return playback to the normal forward direction.
26. **Performance Pads:** These pads have different functions depending on the current pad mode. See [Pad Modes](#) for more information.
27. **Hot Cue:** Press this button to enter Hot Cue Mode.
28. **Loop:** Press this button once to enter Manual Loop Mode, and press it again to enter Auto Loop Mode.
29. **Roll:** Press this button to enter Roll Mode.
30. **Slicer:** Press this button once to enter Slicer Mode, and press it again to enter Slicer Loop Mode.
31. **Parameter ◀/▶:** Use these buttons for various functions in each Pad Mode. See [Pad Modes](#) for more information.
32. **Loop In/Loop Out:** Press either of these buttons to create a Loop In or Loop Out point at the current location. Their placement will be affected by the **Quantize** and **Smart Loops** settings. See [Control Center](#) for more information.
33. **Auto Loop/Loop Move:** Turn this knob to set the size of an automatic loop. The value will be shown in the touchscreen and platter display.
Press this knob to activate or deactivate an automatic loop at the current location of the track.
Tip: You can assign auto loops to pads in Manual Loop Mode. See [Pad Modes](#) for more information.
Press and hold **Shift** and turn this knob to shift the active loop to the left or right.
34. **Beat Jump:** Press either of these buttons to skip backward or forward through the track.
Press and hold **Shift** and then press one of these buttons to increase or decrease the beat jump size.

Front Panel

1. **Front USB Port:** Connect a standard USB drive to this USB port. When you select that USB drive as a source (press the **Source** button), you can use the display to select and load tracks from your USB drive. There are also two similar USB ports on the rear panel. You can use the included USB extension cable to accommodate larger or smaller USB thumb drives.
2. **SD Card Slot:** Insert a standard SD card to this slot. When you select that SD card as a source (press the **Source** button), you can use the display to select and load tracks from your SD card.

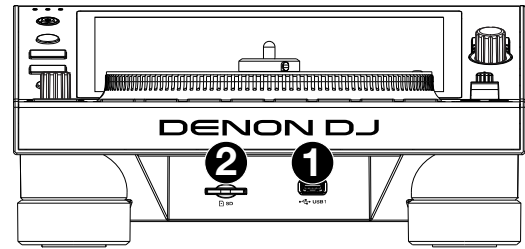

Rear Panel

1. **Power Input:** Use the included locking power cable to connect this input to a power outlet. To remove the power cable, push down on the yellow tab and then pull the cable out of the input. You can also use a standard IEC power cable in place of the included locking power cable.
SC6000M PRIME has a protection circuit to safely eject all media after an unexpected power loss to protect your data from corruption. Reconnect your power source to return to normal operation.
2. **Power Button:** Press this button to power SC6000M PRIME on or off. Power on SC6000M PRIME only **after** you have connected all of your input devices and **before** you power on your amplifiers and loudspeakers. Power off your amplifiers and loudspeakers **before** powering off SC6000M PRIME. Press and hold this button for 10 seconds to reset SC6000M PRIME.
3. **Link Port:** Use the included networking cable to connect this port to another SC6000M PRIME or to your Denon DJ mixer. Each networked SC6000M PRIME can share track databases, timing and BPM information, and other track data over this connection.
4. **USB B Port:** Use a standard USB cable (included) to connect this USB port to an available USB port on your computer. This connection sends and receives MIDI messages to and from the computer.
5. **Rear USB Ports 2/3:** Connect standard USB drives to these USB ports. When you select one of those USB drives as a source (press the **Source** button), you can use the display to select and load tracks from your USB drives. There is also a similar USB port on the front panel.
6. **Layer A/B Outputs:** Use standard RCA cables to connect these outputs to your DJ mixer. The **Layer A** Line Outputs send out the audio signal from Layer A. The **Layer B** Line Outputs send out the audio signal from Layer B.
7. **Digital Outputs A/B:** Use standard digital coaxial cables to connect these 24-bit/96 kHz outputs to devices and mixers such as the Denon DJ X1850 PRIME mixer.
8. **Remote Input:** Use a standard remote start cable to connect this input to the remote-start output of your mixer (if available). While connected to a remote-start-compatible mixer, moving the crossfader toward the side that corresponds to this SC6000M PRIME (or raising the channel fader for its channel) will automatically start the track on the currently selected layer.
9. **Kensington® Lock Slot:** Use this slot to secure SC6000M PRIME to a table or other surface.

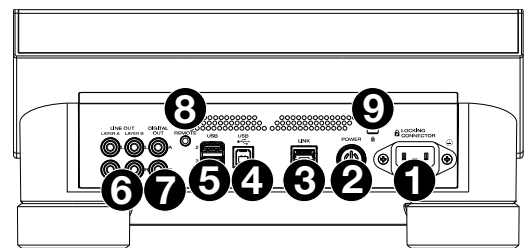

Operation

Touchscreen Overview

Performance View

Track Overview & Waveform

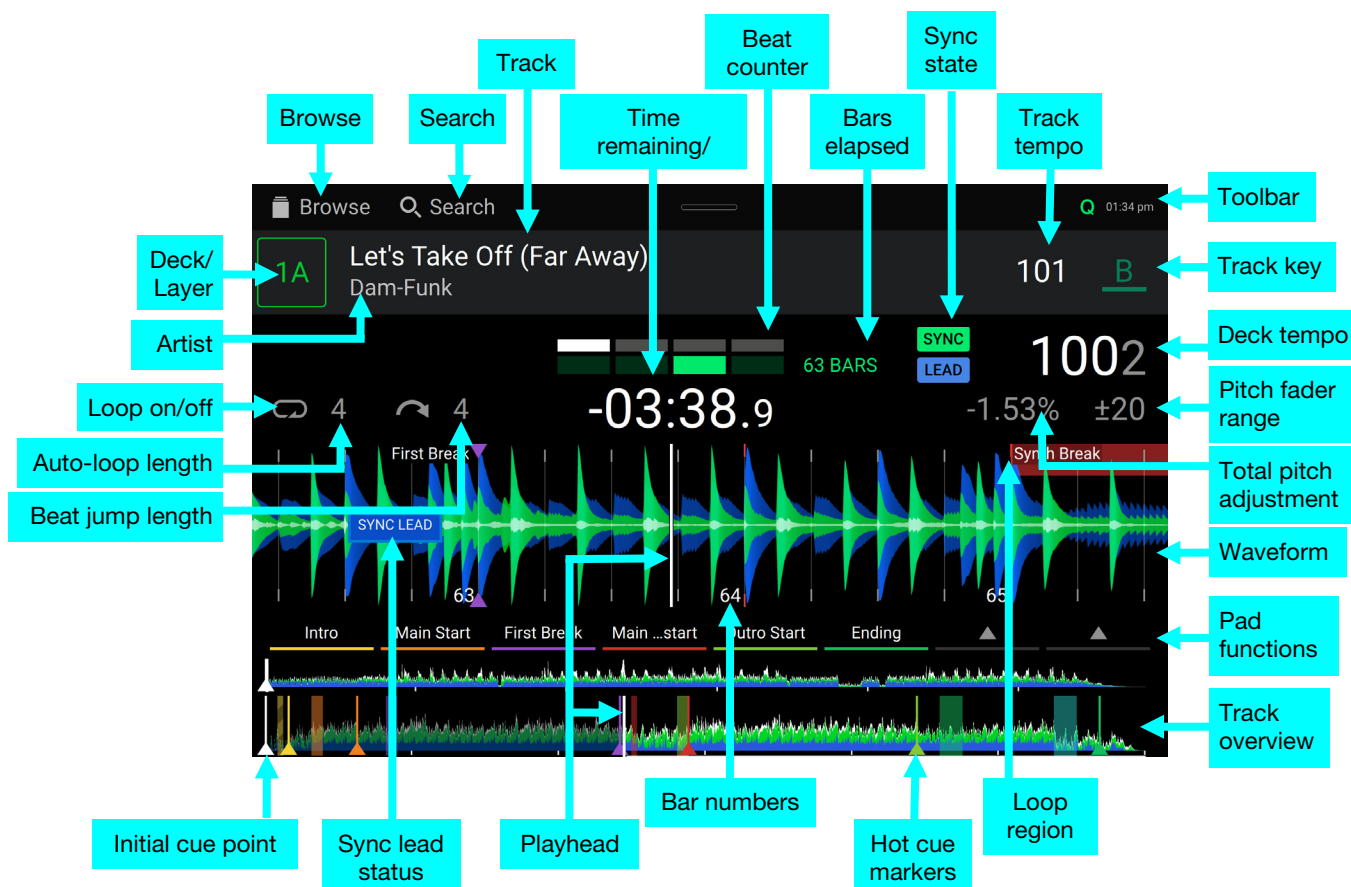

Swipe left or right on the **track overview** to scan through the track while the track is paused.

Note: You can use this feature during playback if Needle Lock is **off**. If Needle Lock is **on**, make sure the platter is in Vinyl Mode (press **Vinyl** so it is lit) and touch the top of the **platter** while swiping the track overview. See [User Profile](#) to learn about Needle Lock.

Spread or pinch your fingers on the **waveform** to zoom in or out of it, respectively. Alternatively, turn the **Select/Zoom** knob.

Tap the time to switch between the elapsed time and remaining time.

Tap the key to show the Key Change Menu, where you can adjust the key of the track.

Tap the Q icon in the toolbar to enable or disable quantization.

Press and hold Shift and **press the View button** to toggle between viewing single layer or dual layer waveforms in Performance View.

Press and hold the Select/Zoom knob for a second to show or hide the beat grid controls. See [Beat Grid Editing](#) for more information.

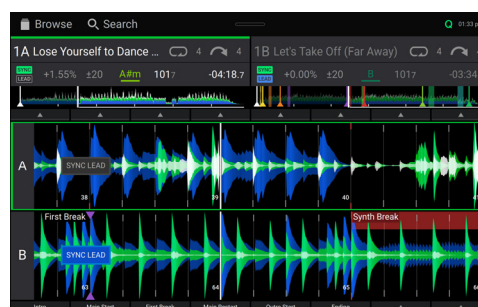

Dual Layer View

Toolbar

The **toolbar** at the top of the touchscreen features shortcuts to [Library View](#) and displays the status of certain hardware and feature settings. **Swipe down** from this area to open the [Control Center](#).



Browse: Tap here to open the full [Library View](#) screen.

Search: Tap here to search for tracks using the keyboard that appears in the display.

Q: Tap here to enable or disable quantization. When enabled, time-based features like triggering cues and loops will snap to the beat-grid according to the **Cue/Loop Quantization** setting in your [User Profile](#).

Continue: The figure-eight icon indicates Continue is enabled, which will keep playing the next track when the active track has ended.

Wi-Fi: Shows the current Wi-Fi connection status.

Link: Shows the current Ableton Link status. Enabling Ableton Link will synchronize the beat, phase, and tempo of Ableton Live and your PRIME hardware over a wireless or wired network.

Time: Displays the current local time. You can adjust the Time in the [Settings](#) menu.

Library View

Use the Library View to view your music library and load a track to the deck. You can also search through playlists, add tracks to the Prepare list, and search through your tracks using sorting and filtering features.

Important: Visit enginedj.com/downloads to download the Engine DJ software.

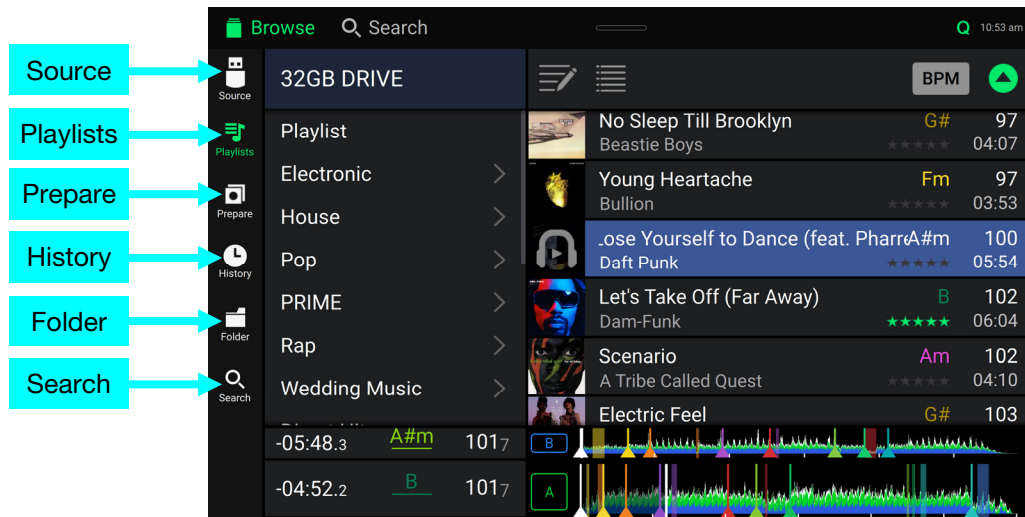

Use the six icons on the left side to navigate while in Library View:

- **Source:** Use this option to select the source device to view tracks from, including your connected media devices and available streaming and cloud services. Tap the Source icon to show the list of available sources, and then tap to select. To enable streaming and cloud services, use the [Settings](#) menu.
- **Playlists:** Your playlists are your collections of tracks, including lists of tracks arranged in a specific order. You may have playlists for different types of clubs or events, for specific genres, etc. You can use the included Engine DJ software to create playlists to use here. See [Editing Playlists](#) for more information on using playlists.
- **Prepare:** You can load tracks to the Prepare list so that you can refer to them later when you want to play them during your performance (rather than searching through your entire library for the next track to play).
- **History:** Use this option to view your playback history.
- **Folder:** Use this option to browse the list of all files on a USB drive or SD card.
- **Search:** Use this option to search through your tracks by keyword. The search results are based on the album name, artist name, track name, key, and tempo. See [Searching & Filtering Tracks](#) for more information.

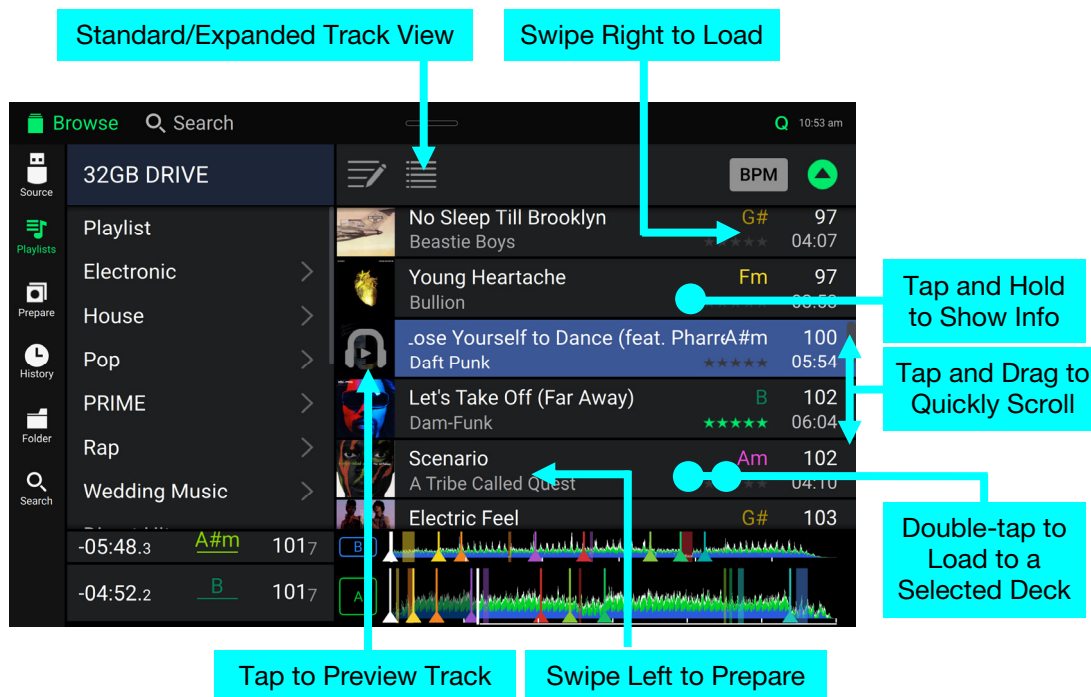

Tap the list icon at the top of the display to toggle between standard and expanded list views.

Swipe a list up or down to browse through it (e.g., your list of playlists or your list of tracks). Alternatively, press the **Back** or **Forward** buttons to select a list, and then turn the **Select/Zoom** knob. Press and hold **Shift** and turn the **Select/Zoom** knob to scroll quickly through the list. You can also tap and drag the scroll bar on the right edge of the list.

Tap an icon or item in a list to select it. Alternatively, press the **Select/Zoom** knob.

Swipe a track to the right to load it to the deck. Alternatively, press the **Select/Zoom** knob or double-tap the track.

Swipe a track to the left to add it to the Prepare list. Alternatively, press and hold **Shift** and press the **Select/Zoom** knob. Swipe a track to the left in the Prepare list to remove it.

Tap and hold your finger on a track to show its information window. Tap the information window to close it.

Tap the track art to preview the track. Tap again to stop the preview. While previewing, tap along the track entry to scan through the track.

Tap the Search field and use the keyboard that appears in the display to search through your tracks by keyword. The search results are based on the album name, artist name, track name, key, and tempo.

Platter Display Overview (SC6000 PRIME only)

Normally, the platter display shows the following information:

- the current position of the playhead.
- the album artwork of the current track.

The platter display temporarily shows the following information:

- the current size of an auto loop after you turn the **Auto Loop** knob.
- the current beat jump size after you press **Shift** and one of the **Beat Jump** buttons to increase or decrease it.
- the current layer after you press the **Layer** button.
- the position of the secondary playhead when **Slip** is active.



Performing

Loading & Removing Tracks

While viewing any track list:

To load a track to the layer currently in focus on the deck, swipe the track to the right. Alternatively, press the **Select/Zoom** knob, or double-tap the track.

To perform instant doubles (load the same track to both layers on the deck), double-press the **Select/Zoom** knob while the track is highlighted.

To add a track to the Prepare list, swipe the track to the left. Alternatively, press and hold **Shift** and press the **Select/Zoom** knob.

To show a track's information, tap and hold your finger on it.

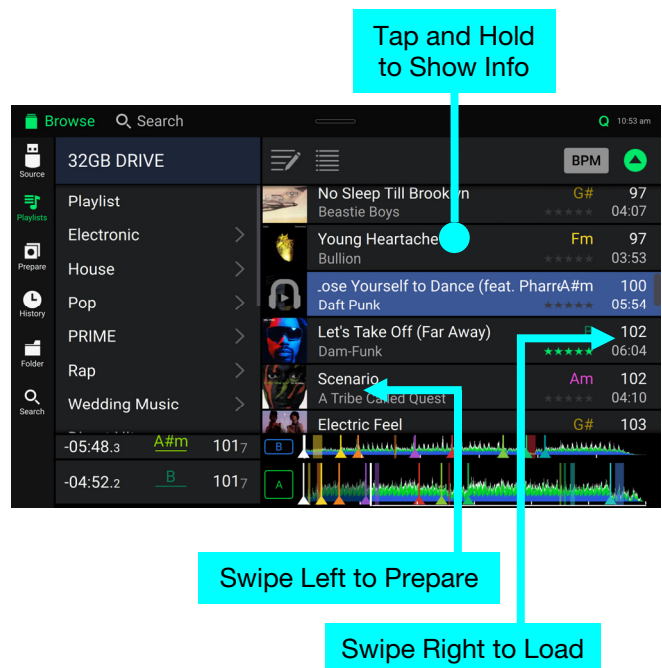

While viewing the Prepare list:

To remove a track from the Prepare list, swipe the track to the left.

To remove all tracks from the Prepare list, tap the **Clear List** icon in the upper-right corner of the touchscreen.

Searching & Filtering Tracks

To **search**, tap the **Search** field and use the keyboard that appears in the display. The search results are based on the following criteria: album name, artist name, track name, key, and tempo.

Note: To reduce search time, only select fields in which you wish to search.

To **hide the keyboard**, tap the **keyboard icon** in the lower-right corner of the virtual keyboard. Alternatively, tap anywhere on the screen other than the keyboard or the Search field.

To **filter your tracks**, tap **Genre, Album, Artist, Key,** or **BPM**, and then tap one of the available options. Only tracks tagged with that genre, album, artist, key, or BPM will be shown. (By default, the key is notated using the Camelot system.)

Note: You can also use the preferences to set whether you want to show tracks with the same key only or tracks with compatible keys as well as the “tolerance” of BPM filter (to include tracks with tempos within 1–15 BPM of the selection). See [User Profile](#) to learn more.

To **sort the list of results**, tap the **Sort By** icon in the upper-right corner, and then tap one of the available options. Tap the **arrow** icon next to this to toggle between ascending and descending order.

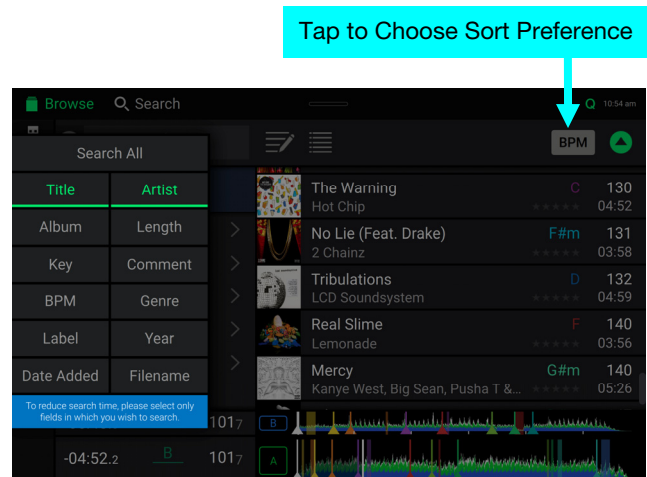
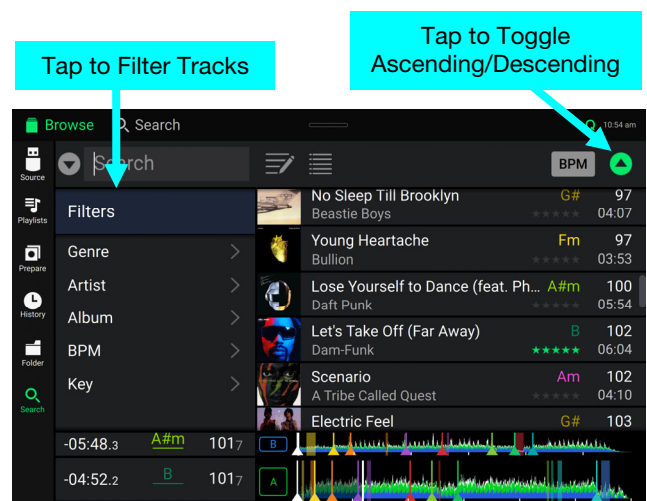
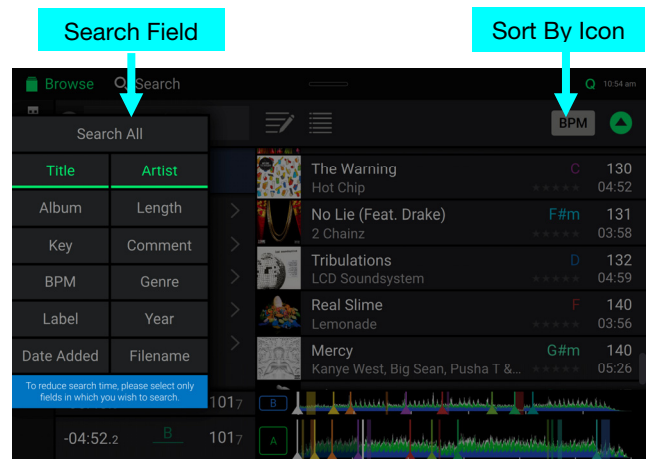

Editing Playlists

Tap the **edit** button at the top of the display while viewing the playlist screen. While editing is active, you can do any of the following:

To make a new playlist, tap + **Create Playlist** in Playlist view.

To add tracks to your playlist, tap a track to select it, and the open circle will become filled. After selecting tracks, tap and hold to move the tracks. You can drag the tracks over a playlist and release your finger to instantly add them.

To reorder tracks in a playlist, tap and hold on the track name (while editing mode is still active), then move your finger up or down to change the track order. You can also reorder playlists in the same way.

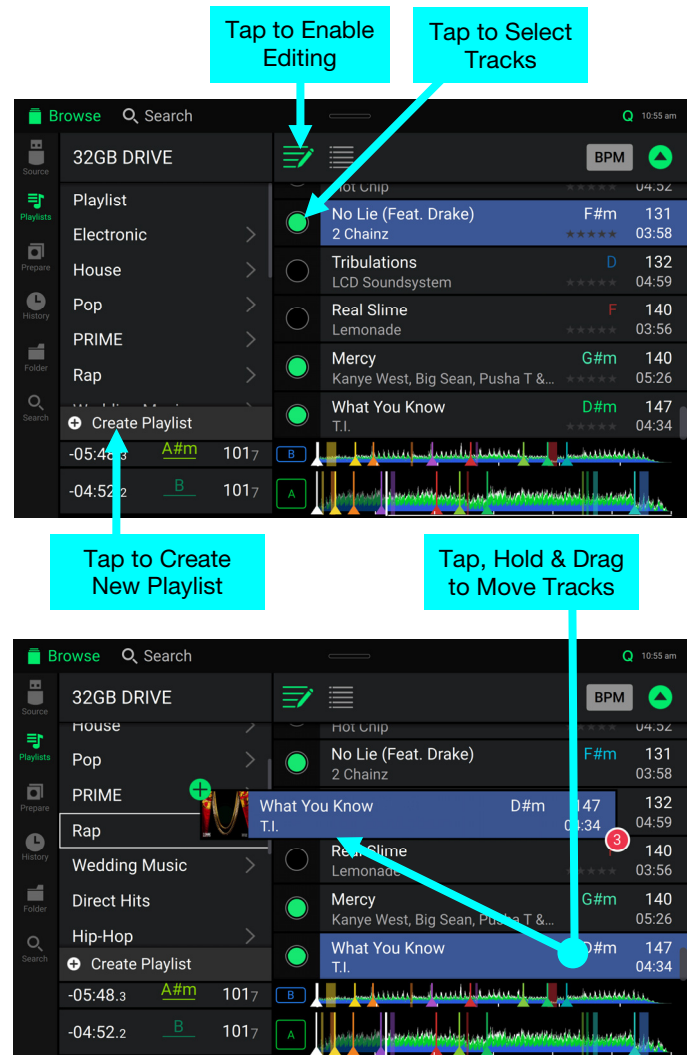

Playback & Cueing

To play or pause a track, press **Play/Pause** (▶/||).

To scratch a track, press **Vinyl** so it is lit brightly and then move the **platter**.

To set the initial cue point, press and hold **Shift** and press **Cue** at the desired location during playback.

To return to the initial cue point and stop, press **Cue**. The button will flash while the unit is paused at the cue point.

To return to the initial cue point and keep playing, press and hold **Shift** and press **Play/Pause** (▶/||).

To reverse playback, press and hold **Shift** and press **Censor/Reverse**. The button will flash while playback is reversed.

To return to normal playback, press **Censor/Reverse**.

To censor playback, press and hold **Censor**.

To return to normal playback, release **Censor**. Normal playback will resume from where it would have been if you had never engaged the Censor feature (i.e., as if the track had been playing forward the whole time).

To skip to the previous or next track, press one of the **Track Skip** ◀/▶ buttons.

To return to the beginning of a track, press **Track Skip** ◀ in the middle of a paused track.

To scan quickly through the track, press and hold **Shift** and then press one of the **Track Skip** buttons.

To enable or disable Slip Mode, press **Slip**. In Slip Mode, you can jump to cue points, use the platters, or pause the track while the track's timeline continues (the lower half of the waveform in the touchscreen will continue moving forward). When you stop whatever action you are performing, the track will resume normal playback from where it would have been if you had never done anything (i.e., as if the track had been playing forward the whole time).

To jump to a specific location in the track:

- If Needle Lock is **disabled**: tap the desired location in the track overview.
- If Needle Lock is **enabled**: pause playback and then tap the desired location in the track overview. Alternatively, make sure the **platter** is in Vinyl Mode (press **Vinyl** so it is lit), touch the top of the **platter**, and tap the desired location in the track overview.

See [User Profile](#) to learn about Needle Lock.

To zoom in and out of the waveform, place two fingers on the display and spread them apart or pinch them together. Alternatively, turn the **Select/Zoom** knob.

Looping & Beat-Jumping

To create and activate an auto loop, press the **Auto Loop** knob.

To set the auto loop length, turn the **Auto Loop** knob to select the number of beats: **1/32, 1/16, 1/8, 1/4, 1/2, 1, 2, 4, 8, 16, 32, or 64**.

To create and activate a manual loop, press **Loop In** to set the start point, and then press **Loop Out** to set the end point. The loop will be activated immediately, and the loop will be indicated as a shaded area in the waveform and track overview.

To deactivate a loop, press the **Auto Loop** knob.

To move the loop, press and hold **Shift** and turn the **Auto Loop** knob while the loop is activated.

To double or halve the length of a loop, turn the **Auto Loop** knob while the loop is activated.

To manually edit the beginning or end of a loop, press **Loop In** or **Loop Out** respectively, then move the platter left or right to shorten or extend the loop region. Commit the edit by pressing **Loop In** or **Loop Out** again.

To beat-jump through a track, press one of the **Beat Jump** buttons. Each press will skip through the track by the set length. You can adjust the beat jump length by pressing and holding **Shift** and pressing either button.

Syncing & Pitch Adjustment

To activate sync, press **Sync** on the unit that you want to control the BPM, which becomes the “sync lead.” After Sync is activated on that unit, press **Sync** on any additional units. The tempo of each unit will immediately synchronize to match the tempo of the sync lead unit.

The Sync state icon in the display will indicate the current status:

 **Sync Off**

 **Sync On**

The Sync behavior is determined by the **Sync Mode** setting in the [User Profile](#) menu.

The Sync Lead icon in the display will indicate the current sync lead status:

 **Sync Lead**

 **Sync Follow**

To deactivate sync on a PRIME hardware unit, press and hold **Shift** and press **Sync**.

To set a different PRIME hardware unit as the primary, press **Master**. All connected units with Sync activated will use the tempo of this unit. You can also tap **Sync Lead** on the touchscreen to select which layer on the primary unit is used for sync.

To adjust the track's pitch, move the **pitch fader**. You can do this only when the deck is not synced.

Important: If Sync is activated, moving the pitch fader on the “primary” SC6000/SC6000M PRIME hardware unit will change the speed of all synced units, while moving the pitch fader on other units will do nothing.

To adjust the track's pitch momentarily, press and hold one of the **Pitch Bend -/+** buttons.

To adjust the range of the pitch fader, press and hold **Shift** and press one of the **Pitch Bend -/+** buttons to select **±4%, 8%, 10%, 20%, 50%, or 100%**.

To reset the track's pitch to 0%, press and hold **Shift** and press **Key Lock/Pitch Reset**. The track's pitch will return to its original pitch (**0%**) regardless of the position of the pitch fader.

To adjust the track's key, tap the key on the **touchscreen** to open the **Key Change Menu**.

Beat Grid Editing

You can edit a track's beat grid directly from your PRIME hardware, the same way as you can when using the Engine DJ software.

To enable **beat grid editing**, open the **Control Center** and tap the **Beat Grid Edit** icon. Alternatively, press and hold the **Select/Zoom** knob for a second.

Important: When the **Cue/Loop Quantization** feature is **on**, hot cue points and loop points will be automatically aligned according to the degree of quantization. See [User Profile](#) to learn about this.



To adjust the position of the beats:

- Tap the **Downbeat Left/Right** buttons to move the beats based on the current analyzed grid.
- Tap the **Shift Left/Right** buttons or nudge the hardware **platter** to "slip" the entire grid left or right.
- Tap the **Insert Anchor** button to move the closest beat to the position of the playhead. All other beats will also shift accordingly. This allows you to create flexible beat grids for tracks with fluctuating tempo.
- Tap the **Delete Anchor** button to delete the closest anchor within a few beats.

To adjust the tempo:

- Tap the **BPM** field to input a new tempo. Use the number pad that appears to input the new value, and then tap the **Enter** button to accept it. Tap the **X** icon to cancel changes and return to the grid edit controls.
- Tap in the **Tap Tempo** icon area to manually set a tempo based on repeated taps.
- Tap the **Decrease/Increase BPM** buttons to decrease and increase BPM in small increments.
- Tap the **2X** and **/2** buttons to double or halve the current BPM.

To reset the beats to the original analyzed tempo and grid, click the **Reset** button.

To lock the beat grid, click the **lock** icon. When locked, further editing is prevented and all other Grid Edit controls will be greyed out.

To exit beat grid editing, tap the **X** in the top-right corner of the touchscreen, or select another mode.

Pad Modes

The 8 pads have different functions in each pad mode. The **Parameter** ◀/▶ buttons will make adjustments specific to each pad mode.

To enter each pad mode, press the corresponding button: **Hot Cue**, **Loop**, **Roll**, or **Slicer**.

Hot Cue Mode



In Hot Cue Mode, you can use each pad to jump to an assigned hot cue point.

Tip: You can use the Engine DJ software to set, name, and assign colors to your hot cue points. The names and colors will appear in the display for reference.

To assign a hot cue to a pad, press a dimly lit pad at the desired location in the track. The pad will light up when a hot cue point is assigned.

To jump to a hot cue point, press the corresponding pad.

To clear a hot cue from a pad, press **Shift** and the desired pad. The pad will turn off when there is no hot cue point assigned to it.

Loop Modes

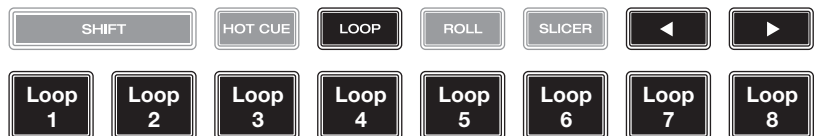

In Manual Loop Mode, you can use each pad to activate an assigned loop. Pressing Loop for the first time will always enter Manual Loop Mode.

Tip: You can use the Engine DJ software to set and name your loops. The names will appear in the display for reference.

To assign a loop to a pad and enable it, press a dimly lit pad to create a Loop In point at the current location, and then press it again to create the Loop Out point at another location. You can also assign an auto loop to a pad by pressing a dimly lit pad while in the auto loop. The loop will activate immediately, and the pad will light up.

To enable a loop, press the corresponding pad. Once a loop has been created, you can retrigger it by pressing the corresponding pad again, depending on the **Saved Loop Behavior** setting.

To enable an active loop, press and hold the **Parameter** ◀ button and press a pad with a saved loop. Active loops will begin looping automatically as soon as they are reached, and are shown with a striped pattern in the track waveform. You can also set these in the Engine DJ software.

To delete a loop, press **Shift** and the desired pad.

In Auto Loop Mode, you can use each pad to create and activate an auto loop. Pressing Loop while in Manual Loop Mode will enter Auto Loop Mode.

To activate an auto loop, press a pad. The display will show the length of the auto loop for each pad.

To deactivate an auto loop, press the pad again.

Roll Mode

(T denotes a triplet-based time division)



In Roll Mode, you can press and hold each pad to trigger a “loop roll” of a certain length while the track’s timeline continues (the lower half of the waveform in the display will continue moving forward). When you release the pad, the track will resume normal playback from where it would have been if you had never done anything (i.e., as if the track had been playing forward the whole time).

To trigger a roll, press the corresponding pad. Pads with triplet-based loop rolls are lit purple.

Slicer Mode



In Slicer Mode (first press), the eight pads represent eight sequential beats—“slices”—in the beat grid. The currently playing slice is represented by the currently lit pad; the light will “move through the pads” as it progresses through the eight-slice phrase. You can press a pad to play that slice. When you release the pad, the track will resume normal playback from where it would have been if you had never pressed it (i.e., as if the track had been playing forward the whole time).

To play a slice, press the corresponding pad. Use the **parameter buttons** to change the length of the repeats.

In Slicer Loop Mode (second press), the eight pads represent eight sequential beats—“slices”—in the beat grid. The currently playing slice is represented by the currently lit pad; the light will “move through the pads” as it progresses through the eight-slice phrase, which will loop (this is the difference between this mode and Slicer Mode). You can press a pad to play that slice. When you release the pad, the track will resume normal playback from where it would have been in the loop if you had never pressed it (i.e., as if the track had been playing forward the whole time).

Control Center

Press the **Shortcuts** button or **swipe down from the toolbar** to open the Control Center. Here, you can quickly adjust commonly used **Parameters** using the widgets in the center of the screen. You can also access the following pages. Click the links below to jump to that part of the guide:

- **User Profile** – This menu is used to edit your performance preferences.
- **Settings** – This menu is used to edit the settings of the PRIME hardware.
- **Source** – This menu is used for selecting your source media device.
- **Wi-Fi** – This menu is used for connecting to and configuring your Wi-Fi network.
- **Engine Lighting** – This menu is used for working with the SoundSwitch Engine Lighting integration.

Parameters

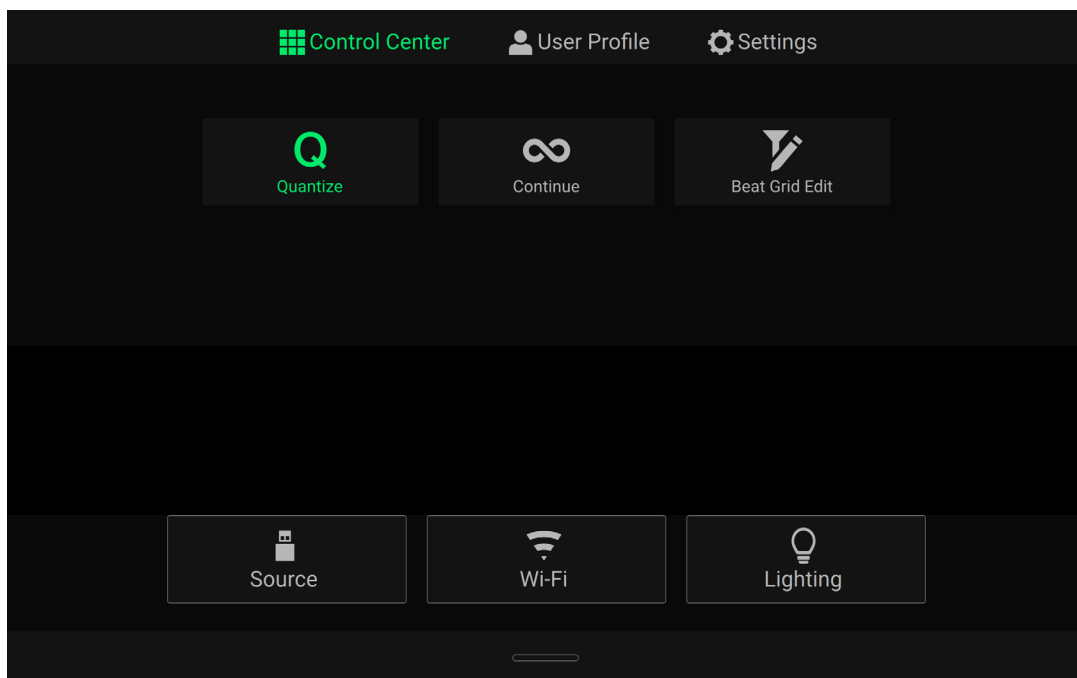

Quantize: Tap this to enable or disable quantization. When enabled, time-based features like triggering cues and loops will snap to the beat-grid according to the **Cue/Loop Quantization** setting in your **User Profile**.

Continue: Tap this to enable or disable continuous playback, which will keep playing the next track when the active track has ended.

Beat Grid Edit: Tap this to access beat grid editing from the touchscreen. See **Beat Grid Editing** for more information.

User Profile

To open the **User Profile** menu, press and hold **View**. Alternatively, press **Shortcuts** to open the Control Center, and then tap the **User Profile** tab.

To close the **User Profile** menu, press **View** again.

In the **User Profile** menu, swipe up or down to scroll through the options, and tap an option to select it.

Press the **Save To My Drive** button to save your settings to a connected drive. User profiles can be loaded when a media device with an Engine DJ profile is connected to your PRIME hardware.

Playback

- **Motorized Platter Start (SC6000M PRIME only):** This setting will determine how quickly your track starts to play. When set to **Normal**, the track will play in relation to the motor start-up speed. When set to **Instant**, the song will begin playing immediately, and the motor and platter will catch up to the song within a few milliseconds.
- **Track Start Position:** This setting determines where the beginning of a track is after it loads. Select the actual start of the file (**Track Start**) or the automatically detected beginning of an audio signal (**Cue Position**).
- **Default Speed Range:** This setting determines the range of the **pitch fader**. Select **±4%**, **8%**, **10%**, **20%**, or **50%**.
- **Nudge Sensitivity (SC6000 PRIME only):** This determines the level of sensitivity when moving the platters: **Min**, **Low**, **Mid**, **High**, or **Max**.
- **Sync Mode:** This setting determines the degree of synchronization applied when you press the Sync button on your PRIME hardware:
 - **Bar:** The tempo will be synced, and the track will be automatically bar-matched with the track on the sync lead deck (the downbeats of each bar will be aligned).
 - **Beat:** The tempo will be synced, and the track will automatically beat-matched with the track on the sync lead deck.
 - **Tempo:** Only the tempo will be synced (the BPM will match that of the sync lead deck).
- **Sync Button Action:** This setting determines how the **Sync** button will act when pressed.
 - **Toggle:** This mode allows you to toggle sync on and off without having to hold **Shift**.
 - **Shift Disable:** This mode requires **Shift** to be held in order to turn off sync.
- **Always show Sync Lead Button:** This setting determines whether the **Sync Lead** button appears over the main waveforms in Performance View. You can tap this button to set the deck as the sync lead.
- **Pitch Control Type:** This setting determines the primary function of the Pitch Bend buttons. Select **Pitch Bend** to keep the primary function as momentarily reducing or increasing the pitch, or select **Range** to set the primary function to adjusting the range of the pitch fader. The function not used as the primary will still be available by holding **Shift** and using the **Pitch Bend** buttons.

Cues/Loops

- **Cue/Loop Quantization:** This setting determines the degree of quantization for time-based features: hot cue points, loops, and loop rolls. Select **1/8 beat**, **1/4 beat**, **1/2 beat**, **1 beat**, or **4 beats**.
- **Paused Hot Cue Behavior:** This setting determines how pads will play their hot cue points. When set to **Momentary**, playback will start from a hot cue point when you press and hold its pad—release the pad to return to the hot cue point. When set to **Trigger**, playback will start from a hot cue point (and continue) when you press and release its pad.
- **Default Loop Size:** This setting determines the default size of an auto loop when you load a new track to the deck: **None**, **1**, **2**, **4**, **8**, **16**, or **32** beats.
- **Default Beat Jump Size:** This setting determines the default size of the beat jump when you load a new track to the deck: **None**, **1**, **2**, **4**, **8**, **16**, or **32** beats.
- **Link Beat Jump / Loop Size Controls:** This setting determines whether the default loop size and beat jump size are always linked to the same value or not. Select **On** or **Off**.
- **Smart Loops:** This setting determines whether or not a manual loop will be automatically expanded or reduced to a conventional length (e.g., 2 beats, 4 beats, 8 beats, etc.) when you set it. Select **On** or **Off**. This setting works independently of the quantization setting.
- **Move Cue To Loop In:** This setting determines whether the song's initial **Cue Point** will automatically be moved to the start of a loop (**On**), or remain at its current point (**Off**).
- **Saved Loop Behavior:** This setting determines the action of loops after they have been saved. When set to **Reloop**, pressing a pad with a saved loop will start playing the loop again. When set to **Disable**, pressing a pad with a saved loop will turn off the loop.

Display

- **Track Title:** This setting determines whether tracks titles are shown as the track's **Filename** or its embedded **Metadata** (tags).
- **Time Format:** This setting determines whether or not pitch adjustment affects how the track time is displayed. When set to **Static**, the track's time corresponds to locations in the track as usual; adjusting the pitch does not affect it. When set to **Dynamic**, the track's time will automatically adjust to account for changes in pitch. For instance, if you set the pitch fader to **-8%**, the track time will increase so it is 8% longer.
- **Track End Warning:** This setting determines how long before the end of a track PRIME hardware will warn you that it is nearing the end. If the track is on the currently selected layer, the **platter** ring and **track overview** will flash. If the track is on the opposite layer, the **Layer** button will flash.
- **On Air Mode:** This setting changes the platter ring illumination when the channel fader on the Denon DJ mixer is up or down, indicating an active or "on air" deck. When this setting is **On**, raising the channel fader will change the platter color from **white** to the selected color. When this setting is **Off**, the user-selected color will always be shown regardless of the channel fader position.

Note: This requires a connection to a compatible Denon DJ mixer via Ethernet.

Safety

- **Lock Playing Deck:** This setting determines whether or not you will be able to load a track to the deck as it is playing. Select **On** or **Off**. When this setting is on, the deck must be paused in order to load a track to it.
- **Needle Lock:** This setting determines whether or not you can tap the **track overview** in the display to jump to that location in the track during playback. Select **On** or **Off**. You can use the track overview while playback is stopped regardless of this setting. Alternatively, make sure the platter is in Vinyl Mode (press Vinyl so it is lit), touch the top of the platter, and tap the desired location in the track overview.
- **Pad Lock:** This setting determines whether the pads and pad mode buttons (**Hot Cue**, **Loop**, **Roll**, **Slicer**) are enabled or disabled. Select **On** or **Off**.

Library

- **Key Notation:** This setting determines how the track key is notated in the display. You can view the key as all **Sharps**, all **Flats**, **Open Key**, or **Camelot**.
- **Key Filter:** This setting determines whether the **Key** filter shows tracks with the same key only (**Match**) or tracks with compatible keys (**Compatible**).
- **BPM Range:** This setting determines the lowest- and highest-possible BPM values that will be used when tracks are analyzed: **58–115**, **68–135**, **78–155**, **88–175** or **98–195** BPM.
- **BPM Filter Tolerance:** This setting determines the “tolerance” of the **BPM** filter so you can include tracks with tempos that are within a small range of the selected tempo. Select **±0**, **1**, **2**, **3**, **5**, **10**, or **15**.
- **Collection Browse Behavior:** This setting determines browsing behavior when using the Library. When set to **Select**, tapping a playlist or folder will select it, and a double-tap is required to open it. When set to **Open**, tapping a playlist or folder will open it.
- **Demo Content:** Use this option to enable or disable the pre-installed demo content.

Deck Colors

- **Deck Colors:** These settings determine the colors of the light ring around the platter for each layer on each player. Tap the arrow next to **A** or **B** to select the layer, and then tap a color to select it. The light ring will change color immediately.

Settings

To open the **Settings** menu, press the **Shortcuts** button, or swipe down from the toolbar, and then tap the **Settings** tab.

To close the **Settings** menu, press **View** again.

In the **Settings** menu, swipe up or down to scroll through the options, and tap an option to select it:

Device

- **Player #:** This setting determines the number of this player. When selecting a source device to browse, this number is shown next to the device name in the display.
- **Layer B:** This determines whether this PRIME hardware will use both deck layers (**On**) or just one (**Off**).
- **Wi-Fi:** This determines whether Wi-Fi connectivity is enabled (**On**) or disabled (**Off**). Tap the **gear icon** to open the Wi-Fi settings. See [Wi-Fi](#) for more information about the Wi-Fi menu.
- **Time/Date:** This displays the current local time and date. Tap **Sync Time** when connected to the internet to automatically sync the time.
- **Time Zone:** Displays the current time zone, formatted as **Continent / City**.
- **Set time zone manually:** Enable this setting and then tap the **gear icon** to manually set your local time zone.
- **Track Preview:** When active, Track Preview will reveal a play button for each song in the library, allowing the songs to be auditioned in the cue without loading a song to the deck. Select **On** or **Off**.
- **Screen Brightness:** This setting determines the brightness of the touchscreen: **Low**, **Mid**, **High**, or **Max**.

Services

- **Lighting:** This determines whether SoundSwitch Engine Lighting is enabled (**On**) or disabled (**Off**). Tap the **gear icon** to open the lighting control interface.
- **Sync:** This determines whether Ableton Link is enabled (**On**) or disabled (**Off**). Ableton Link synchronizes beat, phase, and tempo of Ableton Live and Ableton Link-enabled applications over a wireless or wired network. You must be connected to the internet to use Ableton Link.
- **Streaming:** Use these options to enable or disable connections to streaming service partners. When set to **On**, the selected service will be available in the [Source](#) menu.
- **Cloud:** Use this option to retrieve your Engine library database from a cloud storage service. You must first use the Engine DJ software to back up your database. Then, when this option is set to **On**, the selected service will be available in the [Source](#) menu, and you can access these files over an established internet connection.

Note: We recommend using only high-quality, name brand USB 3.0 or Class U1 or U3 SD cards as source drives, especially when cloud services are enabled.

About / Update

This page displays the product name, current firmware version, and other device information.

- **Update Firmware:** If you are not running the latest firmware, tap **Reboot** to restart the PRIME hardware in Update Mode, which enables you to update its firmware. Follow the firmware update instructions included with the firmware update package you downloaded.
- **Send Anonymous Usage Statistics:** This determines whether or not your usage statistics will be sent occasionally to us, enabling us to improve the PRIME experience.
- **Factory Reset:** Tap here to restore the default factory settings for your device.
- **Legal:** Tap here to view the Denon DJ EULA and patent list.

Source

The Source menu allows you to select a connected media device, streaming service, or cloud service for use with your PRIME hardware. All connected media sources will be shown in the top part of the display, and available streaming and cloud service partners at the bottom of the display.

Tap the device name to select it as your media source. The currently selected source device, if any, will show **Source** next to its name. The currently selected recording device, if any, will show **Rec** next to its name.

Tap the streaming or cloud service name to select it as your media source. If you have not set up a connection to the service yet, you will be prompted to sign in with your username and password or given a web link and code in order to activate your device. Once signed in or activated, you can use the streaming or cloud service to browse and add tracks. Streaming and cloud services may be enabled or disabled in the **Settings** menu.

Tap the Wi-Fi icon at the top of the display to open the **Wi-Fi** connection menu.

Tap the computer icon at the top of the display to switch your PRIME hardware to computer mode. In computer mode, you can use your PRIME hardware to send and receive MIDI messages to and from your computer.

Tap the eject icon next to a drive name to eject that source. If a track from the selected source is currently in use, an alert will appear to note that the tracks will be unloaded. Tap **Eject Anyway** to continue or tap **Cancel** to return to the Source menu.

Tap the X to exit the Source menu.

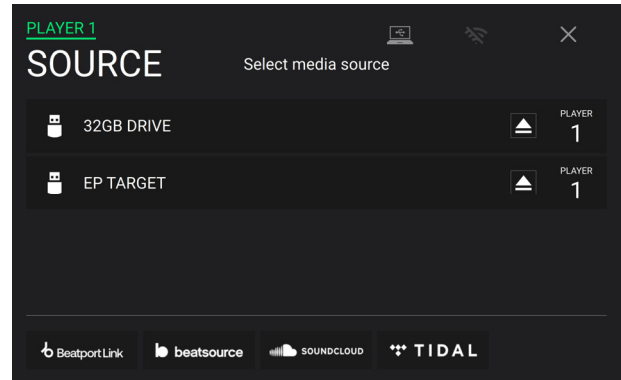

Wi-Fi

The Wi-Fi menu allows you to connect to a local internet network so you can browse connected streaming and cloud services.

Tap the Wi-Fi icon at the top of the page to enable Wi-Fi. Once enabled, a list of local networks will appear on the display.

Tap the desired network name to establish a connection. If a password is required, you will be prompted to enter it. Once a connection is established, **Connected** will appear next to the network name.

Tap the gear icon next to the network name to view information about the network.

Tap the Auto Connect On/Off buttons to enable or disable automatic connection to the network

Tap Forget to forget the network login credentials.

Tap Close or anywhere outside the menu to close the Wi-Fi information menu.

You can also disable Wi-Fi from within this menu by tapping the icon at the top of the display again.

Engine Lighting

The Engine Lighting menu allows you to control connected lighting devices such as DMX fixtures and Smart Lights using SoundSwitch to seamlessly sync your music and lights.

To enable Engine Lighting, make sure the Engine Lighting option under Services in the hardware Settings menu is set to On. Once Engine Lighting is enabled, you can tap the gear icon in the Settings menu to open the lighting control page. You can also access this page after enabling it by double-pressing the View button.

The first time you use Engine Lighting, you can select a Basic or Pro layout for performing (see right):

Basic: A simple interface for controlling Smart Lights, Control Color, Blackout and Strobe Lighting FX.

Pro: Full control of all lighting effects for both DMX and Smart Lights, Control Movements, Strobe and more.

You will also be prompted if you want to connect Philips Hue or NanoLeaf Smart Lights when you first use Engine Lighting. This can also be configured later through the Engine Lighting Preferences menu.

Visit soundswitch.com for more information on using SoundSwitch lighting controls with your SC6000 or SC6000M PRIME.

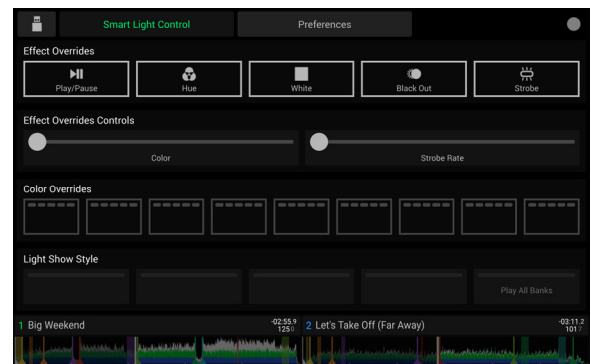
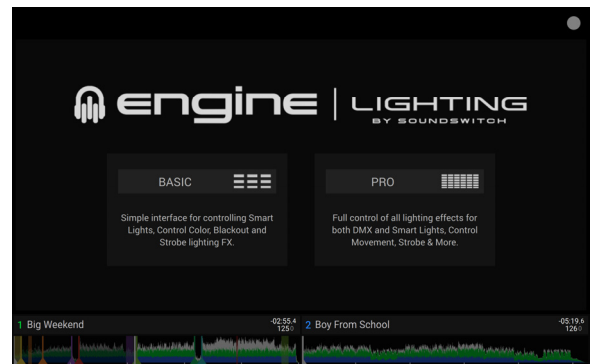

Basic View

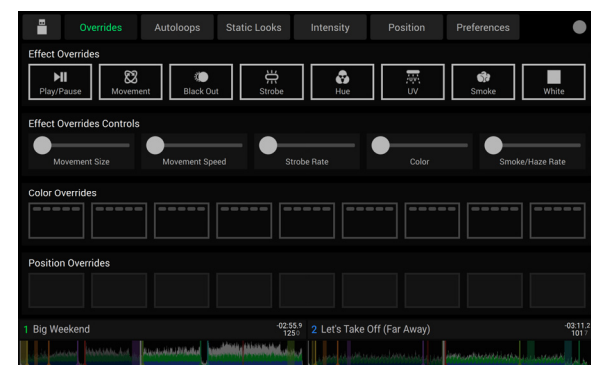

Pro View

Preferences

Tap the **Preferences** tab at the top of the touchscreen to open the Engine Lighting preferences.

General

- **Engine Lighting Status:** This setting displays the current connection status to Engine Lighting devices. When **Running** is shown, Engine Lighting is active. Tap **Stop** to deactivate Engine Lighting. Tap **Start** to reactivate.
- **Connection Status:** These indicators will show whether Engine Lighting is receiving signal from up to four connected players.
- **Sync Offset:** Use this slider to apply a time offset for syncing your connected lights, from **-1** to **0** to **+1** seconds.
- **Show Advanced Controls:** Enable this option to toggle between the **Basic** and **Pro** controls.
- **Randomize Autoloops:** This setting determines whether autoloops are randomized or play in order.
- **Override Scripted Tracks:** This setting determines whether a scripted track that is paired with an audio file is used (**Off**) or whether you can override it using the onboard controls (**On**).
- **Loop Auto Strobe:** This setting allows you to automatically generate strobe effects when a Loop Roll is engaged.
- **Broadcast Art-Net:** This setting allows you to enable or disable sending Art-Net protocol to control DMX interfaces over a network connection.
- **Strobes:** This setting determines whether strobe effects are enabled or disabled.
- **Philips Hue:** Enable this option to connect to available Philips Hue Smart devices.
- **NanoLeaf:** Enable this option to connect to available NanoLeaf devices.
- **Player Mode:** This setting allows you to set whether you are using **2 Player** or **4 Player** operation.
- **Active Faders:** This setting allows you to enable or disable Engine Lighting control on up to four channels at a time. Tap the **CH1–CH4** names to activate each channel.
- **Version:** Displays the current Engine Lighting version.

DMX Interfaces

Use this menu to view connected DMX interfaces and their Universe Assignments.

Philips Hue

Use this menu to set up Philips Hue devices.

NanoLeaf

Use this screen to set up NanoLeaf devices.

Appendix

Technical Specifications

Analog Output	2.0 Vrms (0 dBFS, 1 kHz)	
Signal-to-Noise Ratio	116 dB	
Distortion (THD+N)	< 0.0015%	
Frequency Range	22–22,000 Hz	
Digital Output	Sampling Rate	96 kHz
	Bit Depth	24-bit
Playable Media	Type	SD, SDHC, SDXC card USB mass-storage devices (flash memory, external HDD enclosures)
	File Systems	exFAT (recommended) FAT32
	File Formats	AAC/M4A AIF/AIFF (44.1–192 kHz, 16–32-bit) ALAC FLAC MP3 (32–320 kbps) MP4 Ogg Vorbis WAV (44.1–192 kHz, 16–32-bit)
Platters	8.5" / 216 mm (diameter) Metal construction. SC6000 with display and capacitive touch	
Displays	Main	10.1" / 256 mm (diagonal) Full-color LED-backlit display with touch interface
	Platter (SC6000 PRIME)	2.0" / 50 mm (diameter) Full-color LED-backlit display
Connections	<ul style="list-style-type: none"> (2) RCA output pairs (2) coaxial digital outputs (1) 1/8" (3.5 mm) mini-TS input (remote start) (3) USB Type-A ports (for USB drives) (Rear-panel ports supply 900 mA for USB 3.0 devices, 500 mA for USB 2.0 devices. Front-panel port supplies 500 mA for USB 2.0 devices only.) (1) USB Type-B port (for computer connection) (1) SD card slot (1) Ethernet link port (1) IEC power inlet with locking connector 	

Wi-Fi	Frequency: 2.4 GHz / 5 GHz Standard: 802.11a/b/g/n/ac
Bluetooth Version	5.0
Power	Connection: IEC Input Voltage: 110–240 VAC, 50/60 Hz Consumption: 75 W
Dimensions (width x depth x height)	12.6" x 18.2" x 6.0" / 32.0 x 46.2 x 15.2 cm
Weight	SC6000 PRIME: 12.67 lb. / 5.75 kg SC6000M PRIME: 15.62 lb. / 7.08 kg

Specifications are subject to change without notice.

Trademarks & Licenses

Denon is a trademark of D&M Holdings Inc., registered in the U.S. and other countries. Denon DJ products are produced by inMusic Brands, Inc., Cumberland, RI 02864, USA.

Engine DJ incorporates élastique Pro V3 and [tONaRT] V2 by zplane.development.

Kensington and the K & Lock logo are registered trademarks of ACCO Brands.

macOS is a trademark of Apple Inc., registered in the U.S. and other countries.

SD, SDHC, and SDXC are registered trademarks of SD-3C, LLC.

Windows is a registered trademark of Microsoft Corporation in the United States and other countries.

All other product names, company names, trademarks, or trade names are those of their respective owners.

This product uses software and technology under license. Please visit denondj.com/product-legal for a complete list.

denondj.com

enginedj.com